

JVC

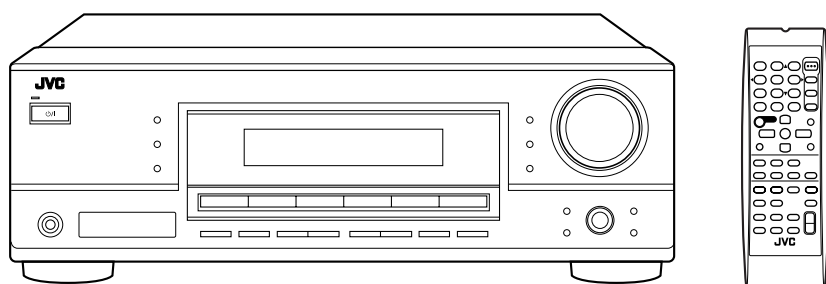

AUDIO/VIDEO CONTROL RECEIVER

RX-5052S



INSTRUCTIONS

Warnings, Cautions, and Others

IMPORTANT for the U.K.

DO NOT cut off the mains plug from this equipment. If the plug fitted is not suitable for the power points in your home or the cable is too short to reach a power point, then obtain an appropriate safety approved extension lead or consult your dealer.

BE SURE to replace the fuse only with an identical approved type, as originally fitted.

If nonetheless the mains plug is cut off ensure to remove the fuse and dispose of the plug immediately, to avoid a possible shock hazard by inadvertent connection to the mains supply.

If this product is not supplied fitted with a mains plug then follow the instructions given below:

IMPORTANT

DO NOT make any connection to the terminal which is marked with the letter E or by the safety earth symbol or coloured green or green-and-yellow.

The wires in the mains lead on this product are coloured in accordance with the following code:

Blue : Neutral
Brown : Live

As these colours may not correspond with the coloured markings identifying the terminals in your plug proceed as follows:

The wire which is coloured blue must be connected to the terminal which is marked with the letter N or coloured black.

The wire which is coloured brown must be connected to the terminal which is marked with the letter L or coloured red.

IF IN DOUBT - CONSULT A COMPETENT ELECTRICIAN.

CAUTION

To reduce the risk of electrical shocks, fire, etc.:

1. Do not remove screws, covers or cabinet.
2. Do not expose this appliance to rain or moisture.

Caution—STANDBY/ON \odot /I button!

Disconnect the mains plug to shut the power off completely. The STANDBY/ON \odot /I button in any position does not disconnect the mains line. The power can be remote controlled.

CAUTION

- Do not block the ventilation openings or holes.
(If the ventilation openings or holes are blocked by a newspaper or cloth, etc., the heat may not be able to get out.)
- Do not place any naked flame sources, such as lighted candles, on the apparatus.
- When discarding batteries, environmental problems must be considered and local rules or laws governing the disposal of these batteries must be followed strictly.
- Do not expose this apparatus to rain, moisture, dripping or splashing and that no objects filled with liquids such as vases, shall be placed on the apparatus.

Caution: Proper Ventilation

To avoid risk of electric shock and fire and to protect from damage.

Locate the apparatus as follows:

Front: No obstructions open spacing.

Sides: No obstructions in 10 cm from the sides.

Top: No obstructions in 10 cm from the top.

Back: No obstructions in 15 cm from the back.

Bottom: No obstructions, place on the level surface.

In addition, maintain the best possible air circulation as illustrated.

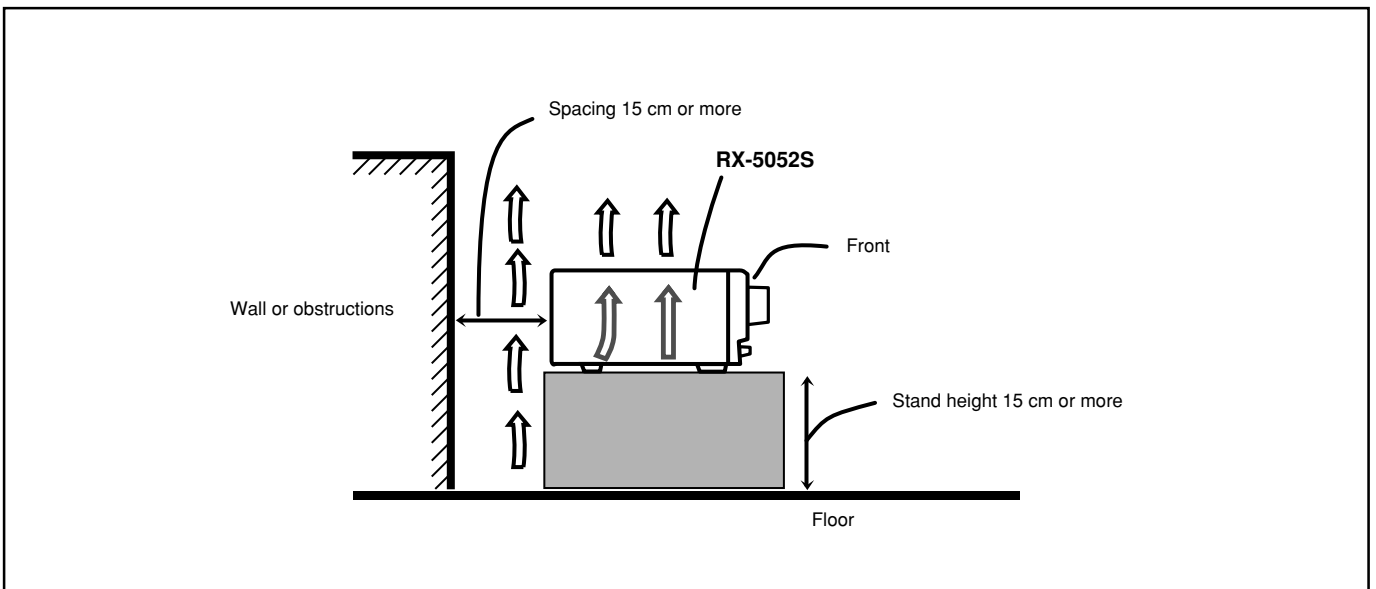

SAFETY INSTRUCTIONS

“SOME DOS AND DON'TS ON THE SAFE USE OF EQUIPMENT”

This equipment has been designed and manufactured to meet international safety standards but, like any electrical equipment, care must be taken if you are to obtain the best results and safety is to be assured.

Do read the operating instructions before you attempt to use the equipment.

Do ensure that all electrical connections (including the mains plug, extension leads and interconnections between pieces of equipment) are properly made and in accordance with the manufacturer's instructions. Switch off and withdraw the mains plug when making or changing connections.

Do consult your dealer if you are ever in doubt about the installation, operation or safety of your equipment.

Do be careful with glass panels or doors on equipment.

DON'T continue to operate the equipment if you are in any doubt about it working normally, or if it is damaged in any way—switch off, withdraw the mains plug and consult your dealer.

DON'T remove any fixed cover as this may expose dangerous voltages.

DON'T leave equipment switched on when it is unattended unless it is specifically stated that it is designed for unattended operation or has a standby mode.

Switch off using the switch on the equipment and make sure that your family know how to do this. Special arrangements may need to be made for infirm or handicapped people.

DON'T use equipment such as personal stereos or radios so that you are distracted from the requirements of traffic safety. It is illegal to watch television whilst driving.

DON'T listen to headphones at high volume as such use can permanently damage your hearing.

DON'T obstruct the ventilation of the equipment, for example with curtains or soft furnishings. Overheating will cause damage and shorten the life of the equipment.

DON'T use makeshift stands and NEVER fix legs with wood screws—to ensure complete safety always fit the manufacturer's approved stand or legs with the fixings provided according to the instructions.

DON'T allow electrical equipment to be exposed to rain or moisture.

ABOVE ALL

— NEVER let anyone, especially children, push anything into holes, slots or any other opening in the case—this could result in a fatal electrical shock.;

— NEVER guess or take chances with electrical equipment of any kind—it is better to be safe than sorry!

Table of Contents

Parts Identification	2	Adjusting Sound	24
Getting Started	4	Basic Adjustment Items	24
Before Installation	4	Basic Procedure	24
Checking the Supplied Accessories	4	■ Adjusting the Equalization Patterns	25
Putting Batteries in the Remote Control	4	■ Adjusting the Speaker Output Levels	25
Connecting the FM and AM (MW) Antennas	4	■ Adjusting the Sound Parameters for the Surround and DSP Modes	25
Connecting the Speakers and Subwoofer	5	Using the Surround Modes	26
Connecting Audio/Video Components	6	Reproducing Theater Ambience	26
■ Analog Connections	6	Introducing the Surround Modes	26
■ Digital Connections	8	Activating the Surround Modes	28
Connecting the Power Cord	8	Using the DSP Modes	29
Basic Operations	9	Reproducing the Sound Field	29
Daily Operational Procedure	9	Introducing the DSP Modes	29
Turning On the Power	9	Activating the DSP Modes	30
Selecting the Source to Play	9	Operating JVC's Audio/Video Components ...	31
Adjusting the Volume	10	Operating Audio Components	31
Turning On and Off the Subwoofer Sound	11	Operating Video Components	32
Selecting the Analog or Digital Input Mode	11	Troubleshooting	33
Changing the Display Brightness	12	Specifications	34
Attenuating the Input Signal	12		
Changing the Source Name	12		
Muting the Sound	13		
Using the Sleep Timer	13		
Receiving Radio Broadcasts	14		
Tuning in to Stations Manually	14		
Using Preset Tuning	14		
Selecting the FM Reception Mode	15		
Receiving FM Stations with RDS	16		
Searching for a Program by PTY Codes	17		
Switching to a Program of Your Choice Automatically	18		
Basic Settings	19		
Quick Speaker Setup	19		
Basic Setting Items	20		
Basic Procedure	20		
■ Setting the Speakers	21		
■ Setting the Speaker Distance	21		
■ Setting the Bass Sounds	21		
■ Selecting the Main or Sub Channel	22		
■ Setting for Easy and Effective Surround Operations	23		
■ Setting the Digital Input Terminals	23		



This mark indicates that ONLY the remote control CAN be used for the operation explained.



This mark indicates that the remote control CANNOT be used for the operation explained. Use the buttons and controls on the front panel.

Parts Identification

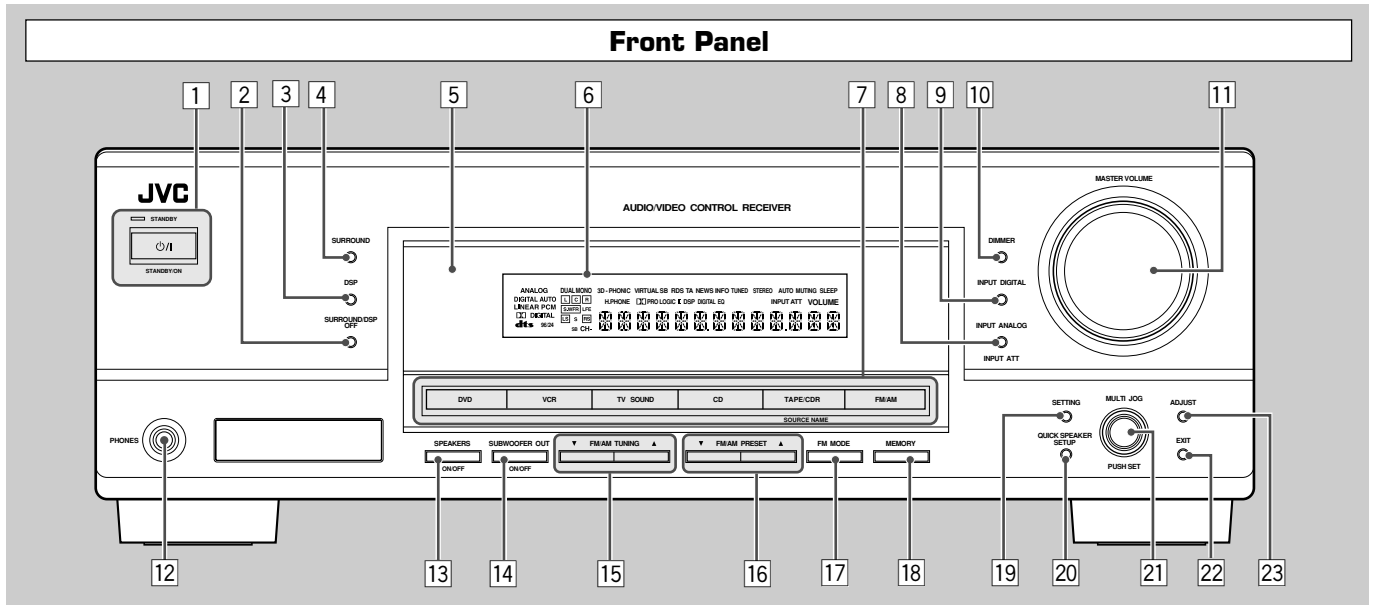

See pages in parentheses for details.

- 1 STANDBY/ON ϕ /I button and STANDBY lamp (9)
- 2 SURROUND/DSP OFF button (28, 30)
- 3 DSP button (29, 30)
- 4 SURROUND button (28)
- 5 Remote sensor
- 6 Display (For details, see "Display" below.)
- 7 Source selection buttons (9, 12)
DVD, VCR, TV SOUND, CD, TAPE/CDR (SOURCE NAME), FM/AM
- 8 INPUT ANALOG button (12)
INPUT ATT button (12)
- 9 INPUT DIGITAL button (11)

- 10 DIMMER button (12)
- 11 MASTER VOLUME control (10)
- 12 PHONES jack (11)
- 13 SPEAKERS ON/OFF button (11)
- 14 SUBWOOFER OUT ON/OFF button (11)
- 15 FM/AM TUNING \blacktriangle / \blacktriangledown buttons (14)
- 16 FM/AM PRESET \blacktriangle / \blacktriangledown buttons (14)
- 17 FM MODE button (15)
- 18 MEMORY button (14)
- 19 SETTING button (20)
- 20 QUICK SPEAKER SETUP button (19)
- 21 MULTI JOG (PUSH SET) dial (19, 20, 24)
- 22 EXIT button (20, 24)
- 23 ADJUST button (24)

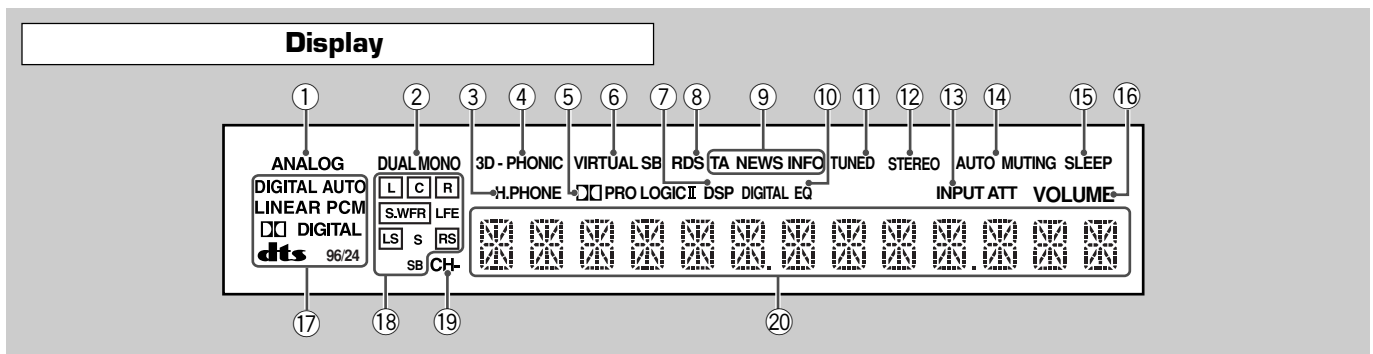

See pages in parentheses for details.

- 1 ANALOG indicator (12)
- 2 DUAL MONO indicator (27)
- 3 H.PHONE indicator (11, 27, 29)
- 4 3D-PHONIC indicator (27, 29, 30)
- 5 \square PRO LOGIC II indicator (26, 29)
- 6 VIRTUAL SB indicator (23)
- 7 DSP indicator (29, 30)
- 8 RDS indicator (16)
- 9 Program type (TA/NEWS/INFO) indicators (18)

- 10 DIGITAL EQ indicator (25)
- 11 TUNED indicator (14)
- 12 STEREO indicator (14)
- 13 INPUT ATT indicator (12)
- 14 AUTO MUTING indicator (15)
- 15 SLEEP indicator (13)
- 16 VOLUME indicator (9)
- 17 Digital signal format indicators (11)
- 18 Speaker indicators and signal indicators (10)
- 19 CH- indicator (14)
- 20 Main display

Remote Control

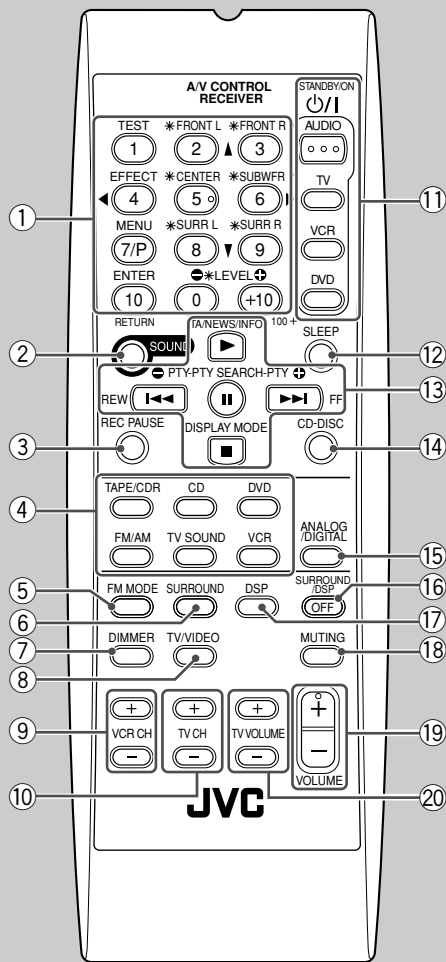

See pages in parentheses for details.

- ① 10 keys for selecting preset channels (15, 31)
10 keys for sound adjustment (25, 31)
10 keys for operating audio/video components (31, 32)
- ② SOUND button (25, 31)
- ③ REC PAUSE button (32)
- ④ Source selection buttons (9, 10)
TAPE/CDR, CD, DVD, FM/AM, TV SOUND, VCR
- ⑤ FM MODE button (15, 31)
- ⑥ SURROUND button (28, 31)
- ⑦ DIMMER button (12, 31)
- ⑧ TV/VIDEO button (32)
- ⑨ VCR CH +/- buttons (32)
- ⑩ TV CH +/- buttons (32)
- ⑪ STANDBY/ON ϕ /I buttons (9, 31, 32)
AUDIO, TV, VCR, DVD
- ⑫ SLEEP button (13, 31)
- ⑬ • Operating buttons for audio/video components
▶, II, ■, ►►/◄◄, FF/REW (31, 32)
• RDS operating buttons (16 – 18)
TA/NEWS/INFO, PTY SEARCH, PTY \oplus , \ominus PTY, DISPLAY MODE
- ⑭ CD-DISC button (32)
- ⑮ ANALOG/DIGITAL button (11, 12, 31)
- ⑯ SURROUND/DSP OFF button (28, 30, 31)
- ⑰ DSP button (29 – 31)
- ⑱ MUTING button (13, 31)
- ⑲ VOLUME +/- button (10, 31)
- ⑳ TV VOLUME +/- buttons (32)

Note:

When you press the one of the audio source selection buttons—TAPE/CDR, CD, and FM/AM—on the remote control, the receiver automatically turns on.

Rear Panel

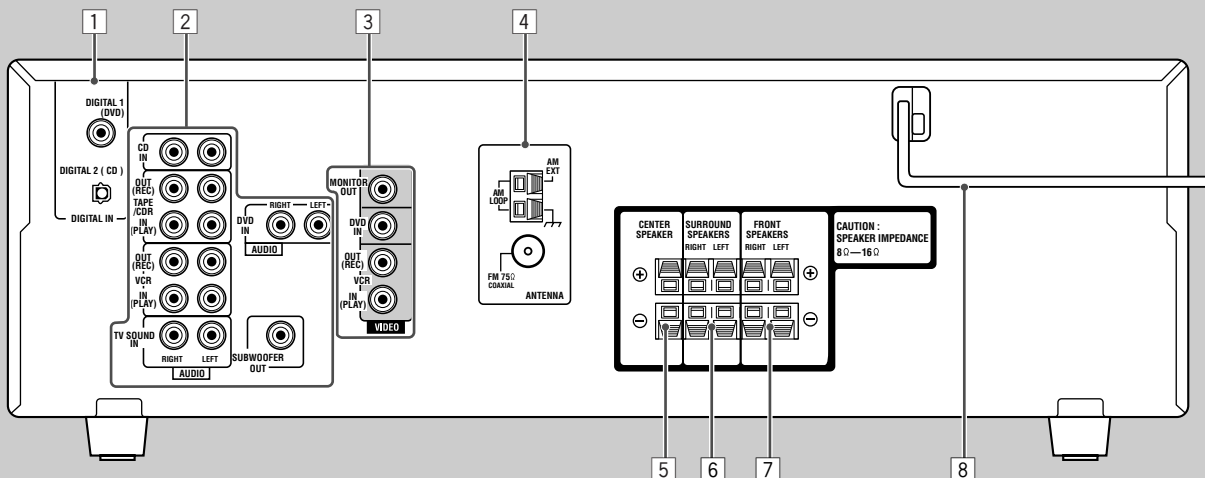

See pages in parentheses for details.

- ① DIGITAL IN terminals (8)
 - Coaxial: DIGITAL 1 (DVD)
 - Optical: DIGITAL 2 (CD)
- ② AUDIO input/output jacks (6, 7)
 - Input: CD IN, TAPE/CDR IN (PLAY), VCR IN (PLAY), TV SOUND IN, DVD IN
 - Output: TAPE/CDR OUT (REC), VCR OUT (REC), SUBWOOFER OUT
- ③ VIDEO input/output jacks (7)
 - Input: DVD IN, VCR IN (PLAY)
 - Output: MONITOR OUT, VCR OUT (REC)
- ④ ANTENNA terminals (4, 5)
- ⑤ CENTER SPEAKER terminals (5)
- ⑥ SURROUND SPEAKERS terminals (5)
- ⑦ FRONT SPEAKERS terminals (5)
- ⑧ AC power cord (8)

Getting Started

Do not connect the AC power cord until all other connections have been made.

This section explains how to connect audio/video components and speakers to the receiver, and how to connect the power supply.

Before Installation

General Precautions

- Be sure your hands are dry.
- Turn the power off to all components.
- Read the manuals supplied with the components you are going to connect.

Locations

- Install the receiver in a location that is level and protected from moisture and dust.
- The temperature around the receiver must be between -5°C and 35°C .
- Make sure there is good ventilation around the receiver. Poor ventilation could cause overheating and damage the receiver.

Handling the receiver

- Do not insert any metal object into the receiver.
- Do not disassemble the receiver or remove screws, covers, or cabinet.
- Do not expose the receiver to rain or moisture.

Checking the Supplied Accessories

Check to be sure you have all of the following items, which are supplied with the receiver.

The number in the parentheses indicates quantity of the pieces supplied.

- Remote Control (1)
- Batteries (2)
- AM (MW) Loop Antenna (1)
- FM Antenna (1)

If anything is missing, contact your dealer immediately.

Putting Batteries in the Remote Control

Before using the remote control, insert the two supplied batteries first.

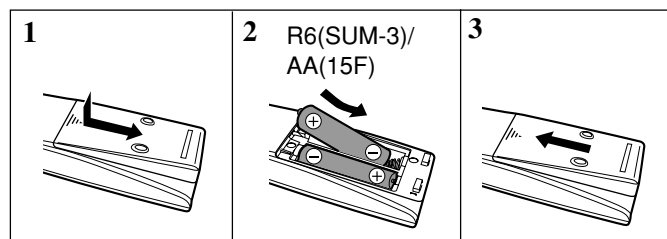

- 1 Press and slide the battery cover on the back of the remote control.
- 2 Insert the batteries.
 - Make sure to match the polarity: (+) to (+) and (-) to (-).
- 3 Replace the cover.

If the remote control cannot transmit signals or operate the receiver correctly, replace the batteries. Use two R6(SUM-3)/AA(15F) type dry-cell batteries.

Note:

Supplied batteries are for the initial setup. Replace for continued use.

CAUTION:

Follow these precautions to avoid leaking or cracking cells:

- Place batteries in the remote control so they match the polarity: (+) to (+) and (-) to (-).
- Use the correct type of batteries. Batteries that look similar may differ in voltage.
- Always replace both batteries at the same time.
- Do not expose batteries to heat or flame.

Connecting the FM and AM (MW) Antennas

FM antenna connections

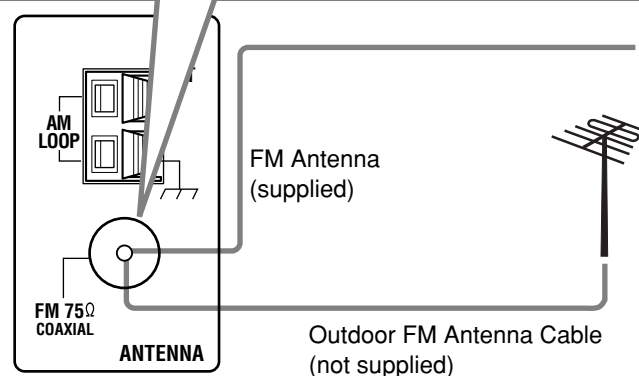
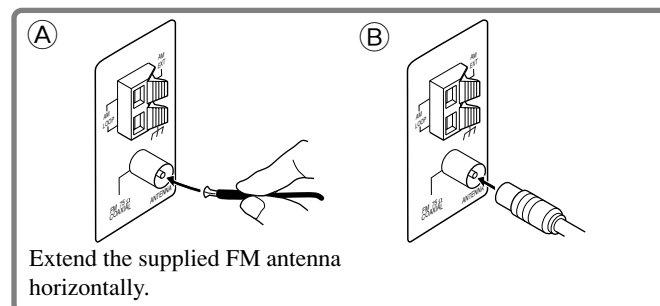
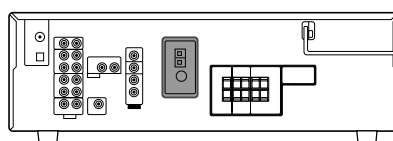

Connect the supplied FM antenna as temporary measure to the FM 75 Ω COAXIAL terminal—(A)

If reception is poor, connect the outdoor FM antenna (not supplied)—(B)

- 1 Disconnect the supplied FM antenna.
- 2 Connect a 75 Ω coaxial cable with the standard type connector (IEC or DIN45325).

Do not connect the AC power cord until all other connections have been made.

AM (MW) antenna connections

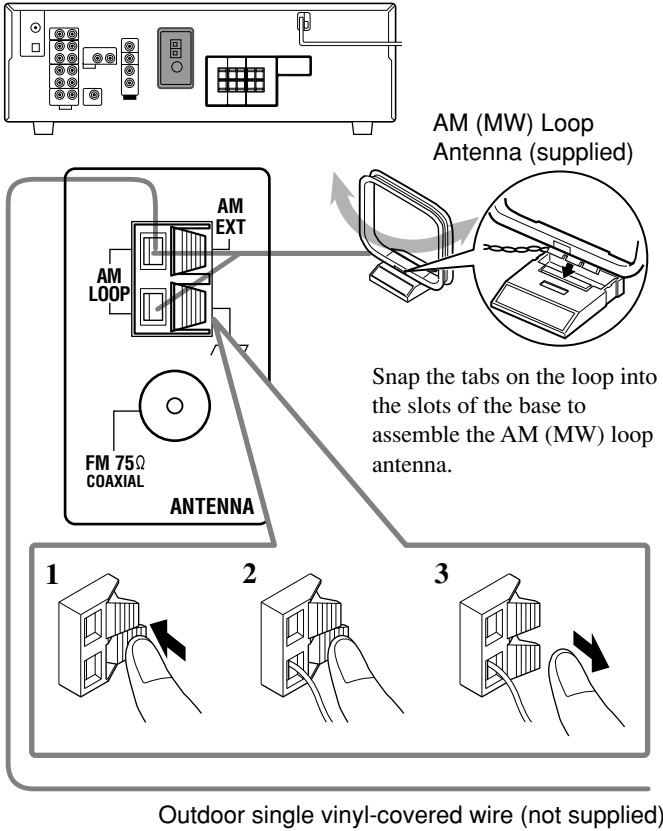

Turn the loop until you have the best reception.

Notes:

- If the AM (MW) loop antenna wire is covered with vinyl, remove the vinyl by twisting it as illustrated.
- Make sure the antenna conductors do not touch any other terminals, connecting cords and power cord. This could cause poor reception.
- If reception is poor, connect an outdoor single vinyl-covered wire (not supplied) to the AM EXT terminal. (Keep the AM (MW) loop antenna connected.)

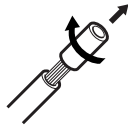

Connecting the Speakers and Subwoofer

You can connect five speakers (a pair of front speakers, a center speaker, and a pair of surround speakers) and a subwoofer.

CAUTIONS:

- Use only the speakers of the SPEAKER IMPEDANCE indicated by the speaker terminals.
- Do not connect more than one speaker to each speaker terminal.

Connecting the speakers

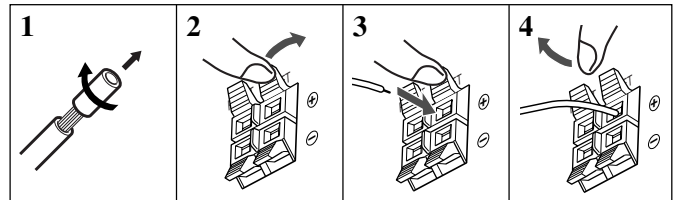

- 1 Twist and remove the insulation at the end of each speaker cord.
- 2 Press and hold the clamp of the speaker terminal.
- 3 Insert the speaker cord.
- 4 Release the finger from the clamp.

For each speaker (except for a subwoofer), connect the (+) and (-) terminals on the rear panel to the (+) and (-) terminals marked on the speakers.

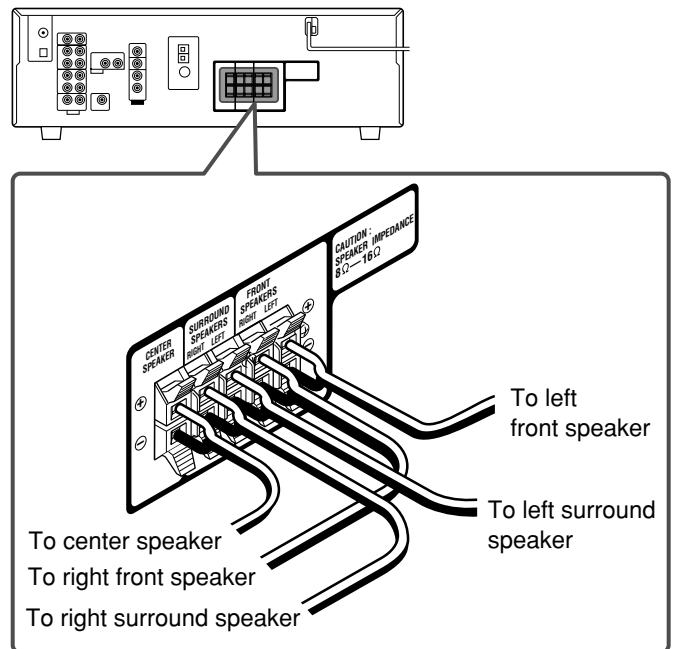

Getting Started

Do not connect the AC power cord until all other connections have been made.

Connecting the subwoofer

You can enhance the bass by connecting a subwoofer. Connect the input jack of a powered subwoofer to the rear panel, using a cable with RCA pin plugs (not supplied).

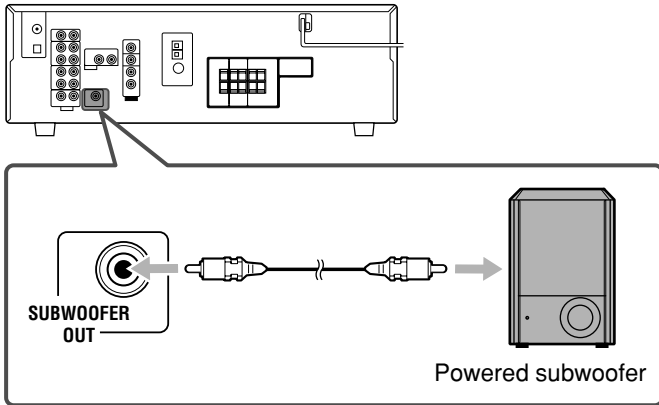

Placing speakers

Front speakers (L/R) and center speaker (C)

- Place these speakers at the same height from the floor, at or near ear level.
- Array across the front of the viewing area.

Surround speakers (LS/RS)

- Place these speakers alongside and slightly to the rear of (but not behind) the listening position; well above ear level (60 cm to 90 cm higher).
- Point these speakers directly across the listening area, but not at the listener's ears.

Subwoofer (S.WFR)

- You can place it wherever you like since bass sound is non-directional. Normally place it in front of you.

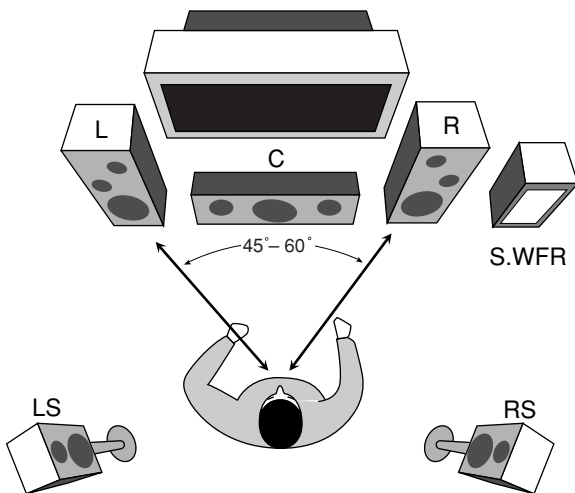

After connecting the speakers, set the speaker installation information properly. You can use Quick Speaker Setup for it (see page 19).

Connecting Audio/Video Components

When connecting individual components, refer also to the manuals supplied with them.

Analog Connections

Audio component connections

Use the cables with RCA pin plugs (not supplied).

- Connect the white plug to the audio left jack, and the red plug to the audio right jack.

CAUTION:

If you connect a sound-enhancing device such as a graphic equalizer between the source components and this receiver, the sound output through this receiver may be distorted.

CD player

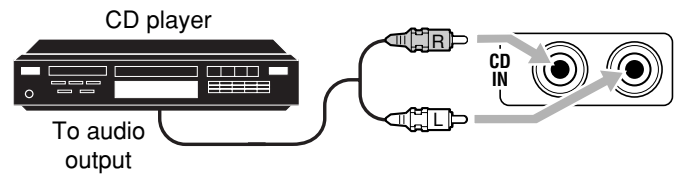
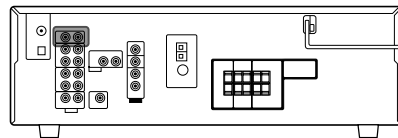

Cassette deck/CD recorder

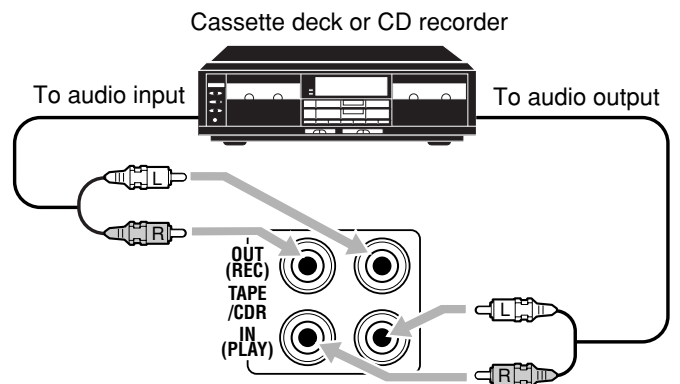
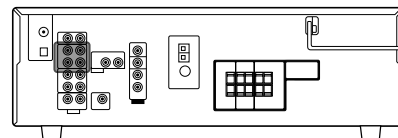

Note:

When connecting a CD recorder to the TAPE/CDR jacks, change the source name to "CDR," which will be shown on the display when it is selected as the source. See page 12 for details.

Do not connect the AC power cord until all other connections have been made.

Video component connections

Use the cables with RCA pin plugs (not supplied). Connect the white plug to the audio left jack, the red plug to the audio right jack, and the yellow plug to the video jack.

VCR

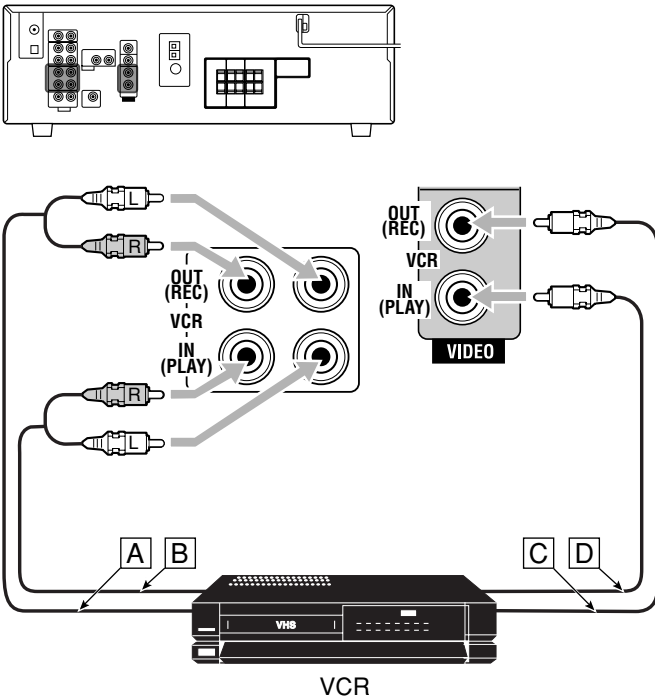

- A To audio input
- B To audio output
- C To composite video input
- D To composite video output

TV

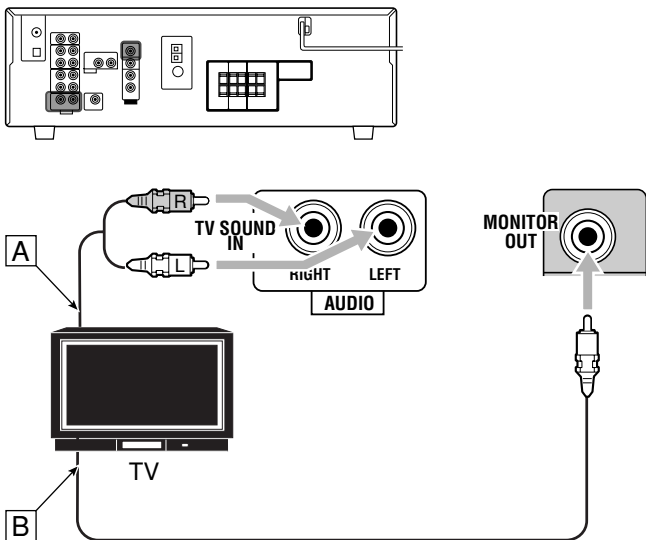

Connect the TV to appropriate MONITOR OUT jacks to view the playback picture from any other connected video components.

- A To audio output
- B To composite video input

DVD player

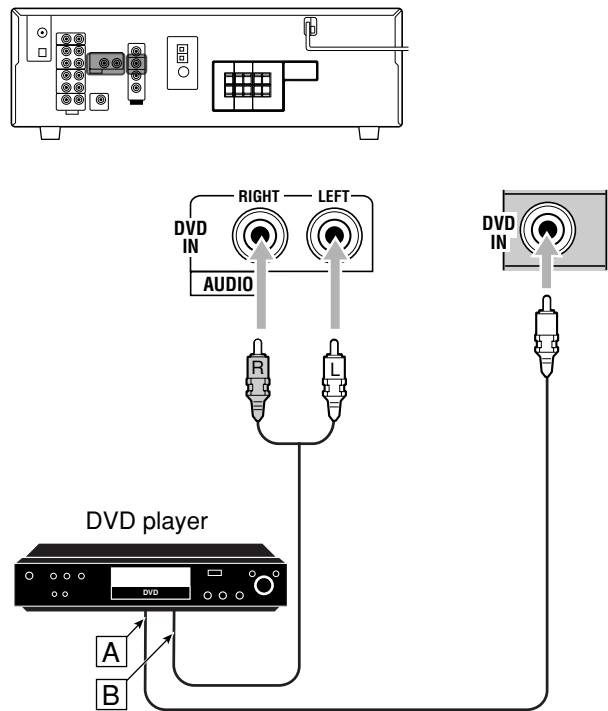

- A To composite video output
- B To left/right front channel audio output (or to audio-mixed output if necessary)

Note:

To enjoy Dolby Digital and DTS multi-channel software (including Dual Mono software), connect the DVD player through the digital input/output terminals.

Digital Connections

By connecting the receiver and the source component through the digital terminals, sound reproduction quality will be much improved. In addition, you can enjoy multi-channel reproduction and some other convenient functions.

IMPORTANT:

- When connecting a video component using the digital terminals, you also need to connect it to the video jacks on the rear. Without connecting it to the video jacks, you can view no playback picture.
- After connecting the components using the DIGITAL IN terminals, set the following correctly if necessary.
 - Set the digital input (DIGITAL IN) terminal setting correctly. For details, see “Setting the Digital Input Terminals” on page 23.
 - Select the digital input mode correctly. For details, see “Selecting the Analog or Digital Input Mode” on page 11.

Digital input terminals

You can connect any digital components having coaxial or optical digital output terminal.

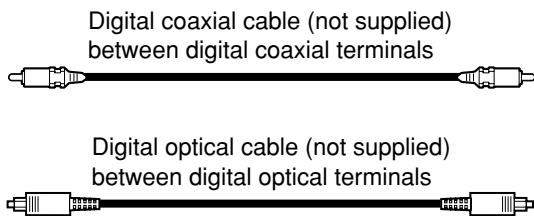

When the component has a digital coaxial output terminal, connect it to the DIGITAL 1 (DVD) terminal, using a digital coaxial cable (not supplied).

When the component has a digital optical output terminal, connect it to the DIGITAL 2 (CD) terminal, using a digital optical cable (not supplied).

Before connecting a digital optical cable, unplug the protective plug.

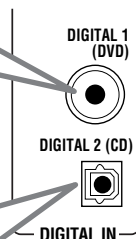
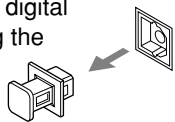

Note:

When shipped from the factory, the DIGITAL IN terminals have been set for use with the following components:

- DIGITAL 1 (coaxial): For DVD player
- DIGITAL 2 (optical): For CD player

Connecting the Power Cord

Before plugging the receiver into an AC outlet, make sure that all connections have been made.

Plug the power cord into an AC outlet.

- Keep the power cord away from the connecting cables and the antenna. The power cord may cause noise or screen interference.

Note:

The preset settings such as preset channels and sound adjustment may be erased in a few days in the following cases:

- When you unplug the power cord.
- When a power failure occurs.

CAUTIONS:

- Do not touch the power cord with wet hands.
- Do not pull on the power cord to unplug the cord. When unplugging the cord, always grasp the plug so as not to damage the cord.

Basic Operations

The following operations are commonly used when you play any sound sources.

Operations hereafter will be explained using the buttons on the front panel.

You can also use the buttons on the remote control for the same functions if they have the same and similar names/marks.

Daily Operational Procedure

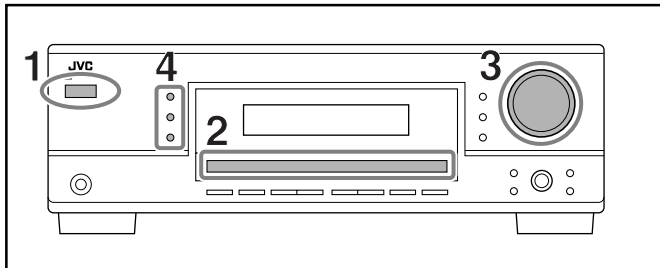

- 1 Turn on the power.**
 - See “Turning On the Power” below.
- 2 Select the source.**
 - See “Selecting the Source to Play” to the right.
- 3 Adjust the volume.**
 - See “Adjusting the Volume” on page 10.
- 4 Select the Surround or DSP modes.**
 - See “Activating the Surround Modes” (page 28) and “Activating the DSP Modes” (page 30).

Turning On the Power

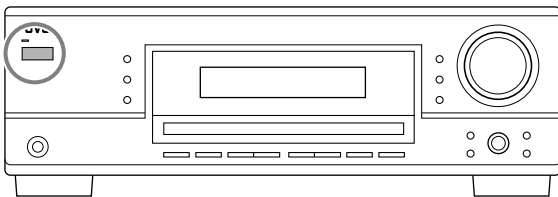

Press **STANDBY/ON** (or **STANDBY/ON** **AUDIO** on the remote control).

The **STANDBY** lamp goes off.

Current source name appears.

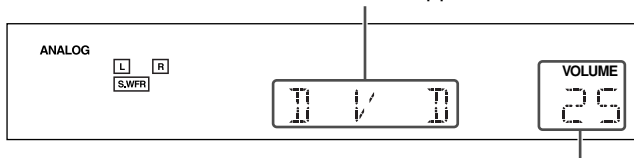

Current volume level appears.

To turn off the power (into standby mode), press **STANDBY/ON** (or **STANDBY/ON** **AUDIO** on the remote control) again.

The **STANDBY** lamp lights up.

Note:

A small amount of power is consumed in standby mode. To turn off the power completely, unplug the AC power cord.

Selecting the Source to Play

When you have connected digital source components using the digital terminals, first change the input mode for these components to the digital input mode (see page 11).

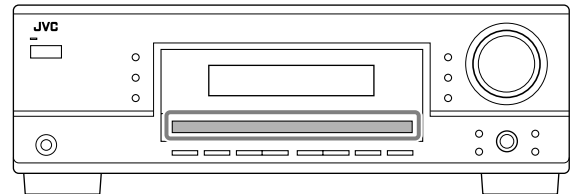

Press one of the source selection buttons.

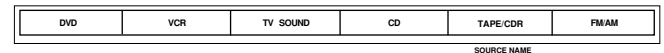
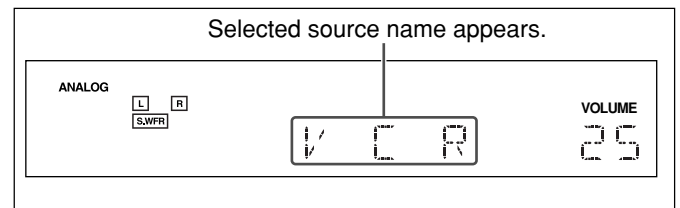

On the front panel

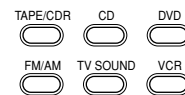

On the remote

Note:

When connecting a CD recorder to the **TAPE/CDR** jacks, change the source name shown on the display. For details, see page 12.

Basic Operations

Speaker and signal indicators on the display

By checking the following indicators, you can easily confirm which speakers you are activating and which signals are coming into this receiver.

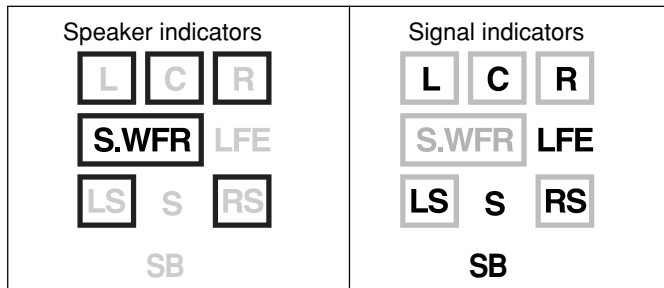

What speaker indicators light depends on the speaker setting (for details, see “Setting the Speakers” on page 21).

- The frames of “L,” “C,” “R,” “LS,” and “RS” light up, when the corresponding speakers are set to “LARGE” or “SMALL.” Sounds come out of the speakers whose speaker indicators is lit on the display.
- The **S.WFR** indicator lights up when the subwoofer is activated (see pages 11 and 21).

The signal indicators light up to show the incoming signals.

- L:**
- **When digital input is selected:** Lights up when the left channel signal comes in.
 - **When analog input is selected:** Always lights up.
- R:**
- **When digital input is selected:** Lights up when the right channel signal comes in.
 - **When analog input is selected:** Always lights up.
- C:** Lights up when the center channel signal comes in.
- LFE:** Lights up when the LFE channel signal comes in.
- LS:** Lights up when the left surround channel signal comes in.
- RS:** Lights up when the right surround channel signal comes in.
- S:** Lights up when the monaural surround channel signal comes in.
- SB:** Lights up when the surround back channel signal comes in.

How to understand the speaker and signal indicator illumination

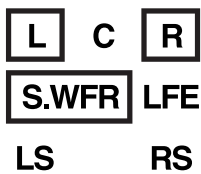

Ex. No sound comes out of the center speaker and surround speakers though center channel and surround channel signals are coming into this receiver.

Selecting different sources for picture and sound

While watching pictures from a video source, you can listen to sound of an audio source.

- Once you have selected a video source, pictures of the selected source are sent to the TV until you select another video source.

Press one of the audio source selection buttons while viewing the picture from a video component such as the VCR or DVD player, etc.

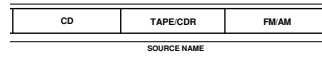

On the front panel

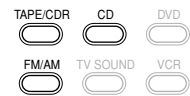

On the remote

Adjusting the Volume

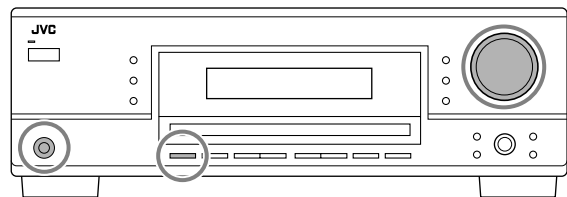

On the front panel:

- To increase the volume,** turn MASTER VOLUME clockwise.
- To decrease the volume,** turn it counterclockwise.

On the remote control:

- To increase the volume,** press VOLUME +.
- To decrease the volume,** press VOLUME -.

CAUTION:

Always set the volume to the minimum before starting any sources. If the volume is set at its high level, the sudden blast of sound energy can permanently damage your hearing and/or ruin your speakers.

Note:

The volume level can be adjusted within the range of “0” (minimum) to “50” (maximum).

Listening with headphones:



You can enjoy not only stereo software but also multi-channel software through the headphones. (Sounds are down-mixed to the front channels while playing multi-channel software.)

- 1 Press **SPEAKERS ON/OFF** to deactivate the speakers. "HEADPHONE" appears for a while, and the H.PHONE indicator lights on the display.
 - If the Surround or DSP mode has been activated, "3D H PHONE" appears for a while (and the DSP indicator also lights up on the display)—3D Headphone Mode (3D H PHONE). For details, see pages 27 and 29.
- 2 Connect the headphones to the **PHONES** jack on the front panel.
 - If you do not deactivate the speakers, no sound comes out of the headphones.

After using the headphones, disconnect the headphones, then press **SPEAKERS ON/OFF** again to activate the speakers.

CAUTION:

- Be sure to turn down the volume....
- Before connecting or putting on headphones, as its high volume can damage both the headphones and your hearing.
 - Before turning on speakers again, as its high volume may come out of the speakers.

Turning On and Off the Subwoofer Sound



You can cancel the subwoofer output even though you have connected a subwoofer and have set "SUBWOOFER" to "SUBWOOFER YES" (see page 21).

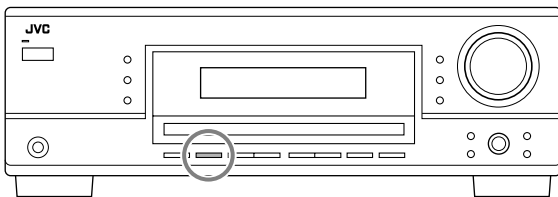

Press **SUBWOOFER OUT ON/OFF** to cancel the subwoofer output.

- Each time you press the button, subwoofer output is deactivated ("SUBWOOFER OFF") and activated ("SUBWOOFER ON") alternately.
- When subwoofer output is canceled, the **[S.WFR]** indicator goes off. Bass sounds (and LFE signals) will be emitted through the front speakers.

Notes:

- When subwoofer output is activated, you can also adjust the subwoofer output level. For details, see page 25.
- You cannot deactivate the subwoofer output when you set "SMALL" for the front speakers on the speaker size setting (see page 21) or using Quick Speaker Setup (see page 19).
- You cannot activate the subwoofer output when you have set "SUBWOOFER" to "SUBWOOFER NO" (see page 21).
- When you change the "SUBWOOFER" setting from "SUBWOOFER NO" to "SUBWOOFER YES" (see page 21), subwoofer output is automatically activated.

Selecting the Analog or Digital Input Mode

When you have connected digital source components using the both analog and digital terminals (see pages 6 to 8), you can select the input mode—either digital or analog—for these components.

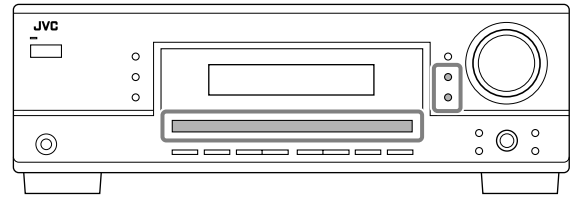

Before you start, remember...

The digital input terminal setting should be correctly done for the sources you want to select the digital input mode (see "Setting the Digital Input Terminals" on page 23).

- 1 Press one of the source selection buttons (**DVD**, **TV SOUND**, **CD**, **TAPE/CDR***) for which you want to change the input mode.

* If "TAPE" is selected as the source, digital input mode is not available. To change the source name, see "Changing the Source Name" on page 12.

- 2 Press **INPUT DIGITAL** to select "DIGITAL AUTO."

The **DIGITAL AUTO** indicator lights up on the display.

- When using the remote control, press **ANALOG/DIGITAL**. Each time you press the button, the analog (**ANALOG**) and digital (**DIGITAL AUTO**) input modes alternate.

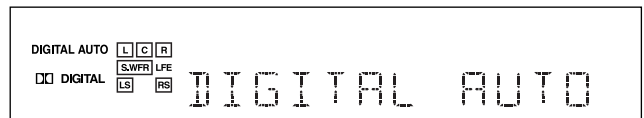

- When selecting "DIGITAL AUTO," the following indicators indicate the digital signal format of the incoming signal.
 - LINEAR PCM** : Lights up when Linear PCM signals come in.
 - [D] DIGITAL** : Lights up when Dolby Digital signals come in.
 - dts** : Lights up when conventional DTS signals come in.
 - dts 96/24** : Lights up when DTS 96/24 signals come in.

No indicator lights up when the receiver cannot recognize the digital signal format of the incoming signals.

Note:

For details about the digital signal formats, see pages 26 and 27.

Continued on the next page

Basic Operations

When playing software encoded with Dolby Digital or DTS, the following symptoms may occur:

- Sound does not come out at the beginning of playback.
- Noise comes out while searching for or skipping chapters or tracks.

In this case, press INPUT DIGITAL repeatedly to select "DOLBY DIGITAL" or "DTS SURROUND."



- Each time you press INPUT DIGITAL, the input mode changes as follows:

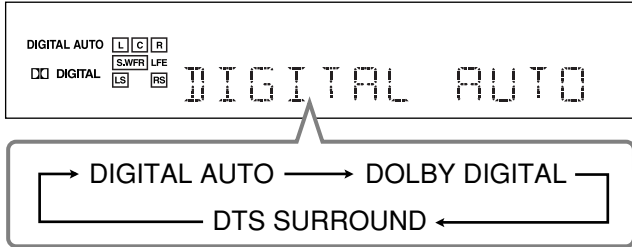

When "DOLBY DIGITAL" or "DTS SURROUND" is selected, the DIGITAL AUTO indicator goes off, and the corresponding digital signal format indicator lights up on the display.

- If the incoming signal does not match the selected digital signal format, the indicator of the selected signal format will flash.

Note:

When you turn off the power or select another source, "DOLBY DIGITAL" and "DTS SURROUND" settings are canceled and the digital input mode is automatically reset to "DIGITAL AUTO."

To select the analog input mode

Press INPUT ANALOG (or ANALOG/DIGITAL on the remote control repeatedly until "ANALOG" appears on the display). The ANALOG indicator lights up.



Changing the Display Brightness

You can dim the display.

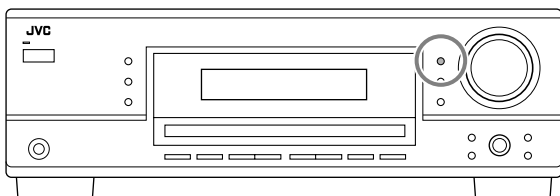

Press DIMMER.

- Each time you press the button, the display dims and brightens alternately.

Attenuating the Input Signal



When the input level of the analog source is too high, the sounds will be distorted. If this happens, you need to attenuate the input signal level to prevent the sound distortion.

- Once you have made adjustment, it is memorized for each analog source.

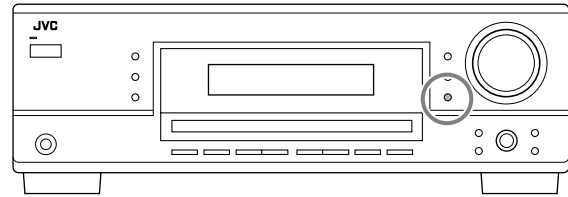

Press and hold INPUT ATT (INPUT ANALOG) so that the INPUT ATT indicator lights up on the display.

- Each time you press and hold the button, the input attenuator mode turns on ("INPUT ATT ON") and off ("INPUT NORMAL").

Changing the Source Name



When you have connected a CD recorder to the TAPE/CDR jacks on the rear panel, change the source name which will be shown on the display.

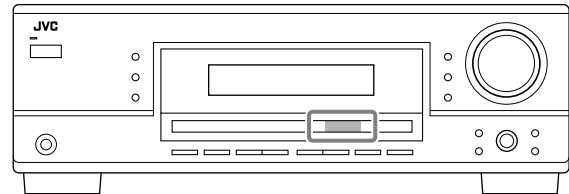

When changing the source name from "TAPE" to "CDR":

- 1 Press TAPE/CDR (SOURCE NAME).
 - Make sure "TAPE" appears on the display.
- 2 Press and hold SOURCE NAME (TAPE/CDR) until "ASSIGN CDR" appears on the display.

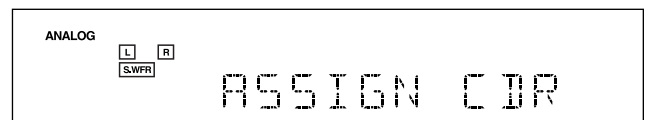

To change the source name back to "TAPE," repeat the same procedure above.

Note:

Without changing the source name, you can still use the connected components. However, there may be some inconvenience.

- "TAPE" will appear on the display when you select the CD recorder.
- You cannot use the digital input (see page 11) for the CD recorder.

The following basic operations are possible only using the remote control.

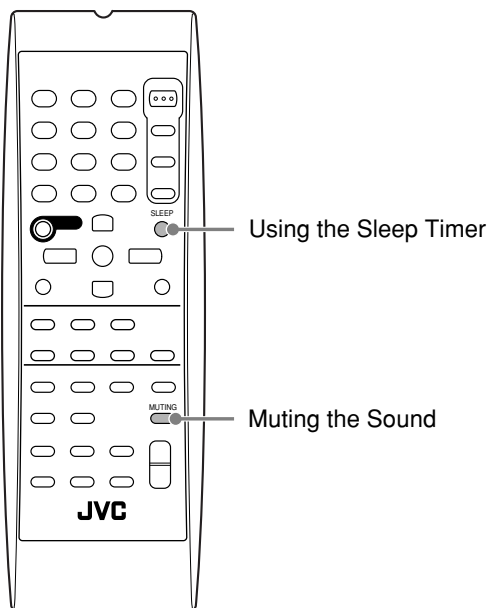

Muting the Sound



Press **MUTING** to mute the sound through all speakers and headphones connected.

“MUTING” appears on the display and the volume turns off (the VOLUME indicator and its level indication go off).

To restore the sound, press **MUTING** again.

- Turning **MASTER VOLUME** on the front panel or pressing **VOLUME +/-** on the remote control also restores the sound.

Using the Sleep Timer



Using the Sleep Timer, you can fall asleep while listening to music. When the shut-off time comes, the receiver turns off automatically.

Press **SLEEP** repeatedly.

The **SLEEP** indicator lights up on the display, and the shut-off time changes in 10 minutes intervals:

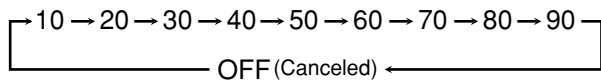

To check or change the time remaining until the shut-off time:

Press **SLEEP** once.

The remaining time until the shut-off time appears in minutes.

- To change the shut-off time, press **SLEEP** repeatedly.

To cancel the Sleep Timer:

Press **SLEEP** repeatedly until “**SLEEP OFF**” appears on the display. The **SLEEP** indicator goes off.

- Turning off the power also cancels the Sleep Timer.

Recording a source

You can record any sources playing through the receiver to a cassette deck (or a CD recorder) connected to the TAPE/CDR jacks and the VCR connected to the VCR jacks at the same time.

While recording, you can listen to the selected sound source at whatever sound level you like without affecting the sound levels of the recording.

Note:

The output volume level, Midnight Mode (see page 22), Equalization patterns (see page 25), Surround modes and DSP modes (see pages 26 to 29) cannot affect the recording.

Basic adjustment auto memory

This receiver memorizes sound settings for each source—

- when you turn off the power,
- when you change the source,
- when you change the analog/digital input modes, and
- when you assign the source name (see page 12).

When you change the source, the memorized settings for the newly selected source are automatically recalled.

The following can be stored for each source:

- Analog/digital input mode (see page 11)
- Input attenuator mode (see page 12)
- Equalization pattern (see page 25)
- Speaker output levels (see page 25)
- Surround and DSP mode selection (see pages 26 and 29)

Notes:

- If the source is FM or AM, you can assign a different setting for each band.
- A sound setting assigned for a digital component is valid for both the analog and digital input modes.

Receiving Radio Broadcasts

You can browse through all the stations or use the preset function to go immediately to a particular station.

Tuning in to Stations Manually

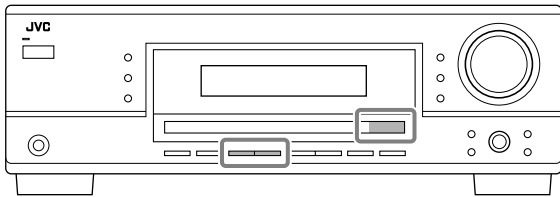

1 Press FM/AM to select the band (FM or AM).

Each time you press the button, the band alternates between FM and AM (MW).

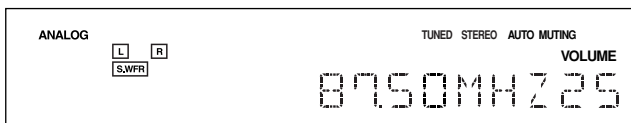
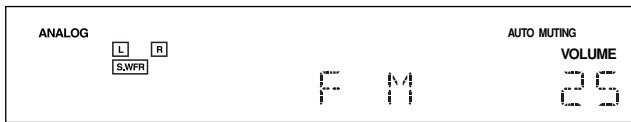

The last received station of the selected band is tuned in.

2 Press FM/AM TUNING ▲ or ▼ repeatedly until you find the frequency you want.

- Pressing FM/AM TUNING ▲ increases the frequency.
- Pressing FM/AM TUNING ▼ decreases the frequency.

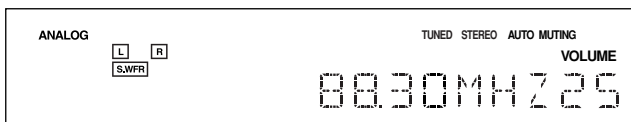

Notes:

- When a station of sufficient signal strength is tuned in, the TUNED indicator lights up on the display.
- When an FM stereo program is received, the STEREO indicator also lights up.
- When you hold and then release the button in step 2, the frequency keeps changing until a station is tuned in.

Using Preset Tuning

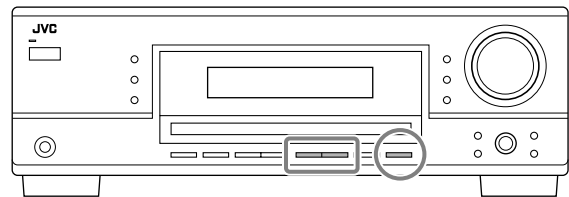

Once a station is assigned to a channel number, the station can be quickly tuned in. You can preset up to 30 FM and 15 AM (MW) stations.

To store the preset stations



Before you start, remember...

There is a time limit in doing the following steps. If the setting is canceled before you finish, start from step 2 again.

1 Tune in the station you want to preset (see “Tuning in to Stations Manually”).

- If you want to store the FM reception mode for this station, select the FM reception mode you want. See “Selecting the FM Reception Mode” on page 15.

2 Press MEMORY.

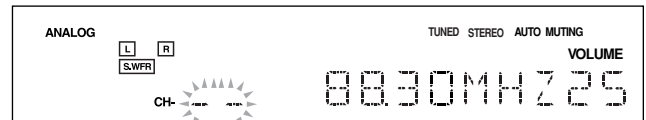

The channel number position starts flashing on the display for about 5 seconds.

3 Press FM/AM PRESET ▲ or ▼ to select a channel number while the channel number position is flashing.

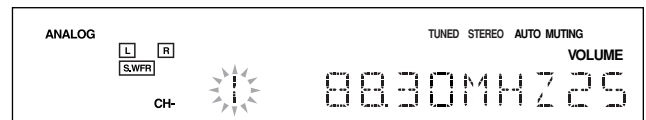

4 Press MEMORY again while the selected channel number is flashing on the display.

The selected channel number stops flashing.

The station is assigned to the selected channel number.

5 Repeat steps 1 to 4 until you store all the stations you want.

To erase a stored preset station

Storing a new station on a used number erases the previously stored one.

To tune in a preset station

On the front panel:

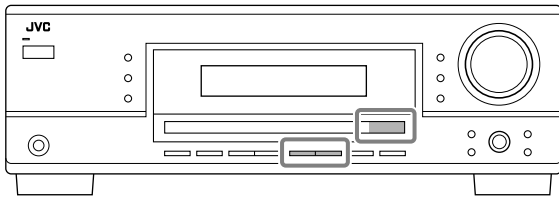

- 1 Press FM/AM to select the band (FM or AM).**
Each time you press the button, the band alternates between FM and AM (MW).
- 2 Press FM/AM PRESET ▲ or ▼ until you find the channel you want.**
 - Pressing FM/AM PRESET ▲ increases the number.
 - Pressing FM/AM PRESET ▼ decreases the number.

On the remote control:

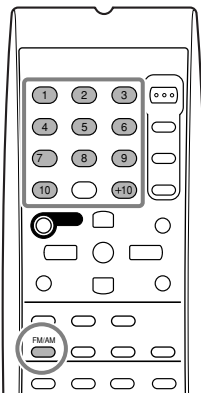

- 1 Press FM/AM to select the band (FM or AM).**
The last received station of the selected band is tuned in.
 - Each time you press the button, the band alternates between FM and AM (MW).
- 2 Press the 10 keys to select a preset channel number.**
 - For channel number 5, press 5.
 - For channel number 15, press +10 then 5.
 - For channel number 20, press +10 then 10.
 - For channel number 30, press +10, +10, then 10.

Note:

When you use the 10 keys on the remote control, be sure that they are activated for the tuner, not for the CD and others. (See page 31.)

Selecting the FM Reception Mode

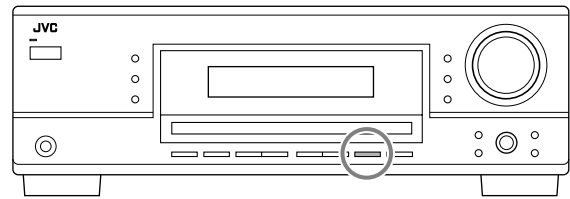

When an FM stereo broadcast is hard to receive or noisy, you can change the FM reception mode while receiving an FM broadcast.

- You can store the FM reception mode for each preset station (see page 14).

While listening to an FM station, press FM MODE.

- Each time you press the button, the FM reception mode alternates between “AUTO MUTING” and “MODE MONO.”

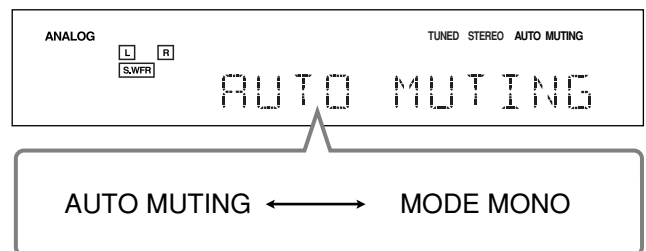

AUTO MUTING: Normally select this.

When a program is broadcasted in stereo, you will hear stereo sound; when in monaural, you will hear monaural sounds. This mode is also useful to suppress static noise between stations.

The AUTO MUTING indicator lights up on the display. (Initial setting)

MODE MONO: Select this to improve the reception (but stereo effect will be lost).

In this mode, you will hear noise while tuning in to the stations.

The AUTO MUTING indicator goes off from the display (the STEREO indicator goes off).

Note:

After you operate any source other than the tuner using the remote control, the FM MODE button on the remote control does not work. In this case, press FM/AM on the remote control, then press FM MODE.

Receiving Radio Broadcasts

The following tuner operations are possible only using the remote control.

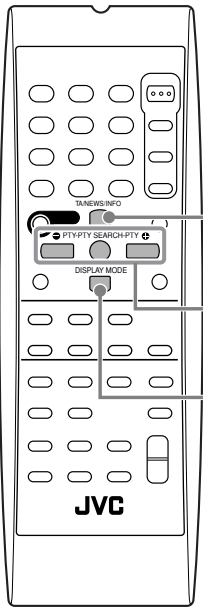

Switching to a Program of Your Choice Automatically

Searching for a Program by PTY Codes

Receiving FM Stations with RDS (To show the RDS information)

To show the RDS information

You can see the RDS information the station sends on the display.

Press **DISPLAY MODE** on the remote control while listening to an FM station.

- Each time you press the button, the display changes to show you the following information:

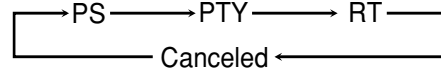

PS (Program Service): While searching, “PS” appears and then the station names will be displayed. “NO PS” appears if no signal is sent.

PTY (Program Type): While searching, “PTY” appears and then the type of the broadcast program will be displayed. “NO PTY” appears if no signal is sent.

RT (Radio Text): While searching, “RT” appears and then text messages the station sends will be displayed. “NO RT” appears if no signal is sent.

IMPORTANT:

Before using RDS operating buttons, press FM/AM on the remote control so that RDS operating buttons work for tuner operation.

Receiving FM Stations with RDS

RDS (Radio Data System) allows FM stations to send an additional signal along with their regular program signals. For example, the stations send their station names, as well as information about what type of program they broadcast, such as sports or music, etc.

- When tuned in to an FM station which provides the RDS service, the RDS indicator lights up on the display.

With the receiver, you can receive the following types of RDS signals.

PS (Program Service): Shows commonly known station names

PTY (Program Type): Shows types of broadcast programs

RT (Radio Text): Shows text messages the station sends

Enhanced Other Networks:

Provides the information about the types of the programs sent by other RDS stations of the different Networks than the one being received.

Notes:

- If searching finishes at once, “PS,” “PTY,” and “RT” will not appear on the display.
- Some special characters and marks may not be displayed correctly. (The display cannot show accented letters, “A,” for instance, may stand for accented “A’s” like “Â, Ä, Ã, Á, À, and Â.”)

Notes:

- RDS is not available for AM (MW) broadcasts.
- Not all FM stations provide RDS signals, nor do all RDS stations provide the same services. If in doubt, check with local radio stations for details on RDS in your area.
- RDS may not operate correctly if the station tuned is not transmitting RDS signal properly or if the signal strength is weak.

Searching for a Program by PTY Codes



One of the advantages of the RDS service is that you can locate a particular kind of program from the preset channels (see pages 14 and 15) by specifying the PTY codes.

To search for a program using the PTY codes

Before you start, remember...

- To stop searching any time during the process, press PTY SEARCH while searching.
- There is a time limit in doing the following steps. If the setting is canceled before you finish, start from step 1 again.

1 Press PTY SEARCH while listening to an FM station.

“PTY SELECT” flashes on the display.

2 Press PTY \oplus or \ominus PTY until the PTY code you want appears on the display, while “PTY SELECT” is flashing.

- Each time you press the button, the PTY codes change as follows:

NONE \rightleftharpoons NEWS \rightleftharpoons AFFAIRS \rightleftharpoons INFO (Information) \rightleftharpoons
 SPORT \rightleftharpoons EDUCATE (Education) \rightleftharpoons DRAMA \rightleftharpoons
 CULTURE \rightleftharpoons SCIENCE \rightleftharpoons VARIED \rightleftharpoons
 POP M (Music) \rightleftharpoons ROCK M (Music) \rightleftharpoons
 EASY M (Music) \rightleftharpoons LIGHT M (Music) \rightleftharpoons
 CLASSICS \rightleftharpoons OTHER M (Music) \rightleftharpoons WEATHER \rightleftharpoons
 FINANCE \rightleftharpoons CHILDREN \rightleftharpoons SOCIAL \rightleftharpoons
 RELIGION \rightleftharpoons PHONE IN \rightleftharpoons TRAVEL \rightleftharpoons LEISURE \rightleftharpoons
 JAZZ \rightleftharpoons COUNTRY \rightleftharpoons NATION M (Music) \rightleftharpoons
 OLDIES \rightleftharpoons FOLK M (Music) \rightleftharpoons DOCUMENT \rightleftharpoons
 TEST \rightleftharpoons ALARM \rightleftharpoons (back to the beginning)

- For details about each PTY code, see the right column.

3 Press PTY SEARCH again, while the PTY code selected in the previous step is still on the display.

While searching, the selected PTY code and “SEARCH” alternate on the display.

The receiver searches 30 preset FM stations, stops when it finds the one you have selected, and tunes in to that station.

To continue searching after the first stop

Press PTY SEARCH again while the indications on the display are flashing.

If no program is found, “NOT FOUND” appears on the display.

Description of the PTY codes:

NEWS:	News.
AFFAIRS:	Topical program expanding or enlarging upon the news—debate, or analysis.
INFO:	Programs the purpose of which is to impart advice in the widest sense.
SPORT:	Programs concerned with any aspect of sports.
EDUCATE:	Educational programs.
DRAMA:	All radio plays and serials.
CULTURE:	Programs concerning any aspect of national or regional culture, including language, theater, etc.
SCIENCE:	Programs about natural sciences and technology.
VARIED:	Used for mainly speech-based programs such as quizzes, panel games, and personality interviews.
POP M:	Commercial music of current popular appeal.
ROCK M:	Rock music.
EASY M:	Current contemporary music considered to be “easy-listening.”
LIGHT M:	Instrumental music, and vocal or choral works.
CLASSICS:	Performances of major orchestral works, symphonies, chamber music, etc.
OTHER M:	Music not fitting into any of the other categories.
WEATHER:	Weather reports and forecasts.
FINANCE:	Stock Market reports, commerce, trading, etc.
CHILDREN:	Programs targeted at a young audience.
SOCIAL:	Programs about sociology, history, geography, psychology, and society.
RELIGION:	Religious programs.
PHONE IN:	Involving members of the public expressing their views either by phone or at a public forum.
TRAVEL:	Travel information.
LEISURE:	Programs about recreational activities.
JAZZ:	Jazz music.
COUNTRY:	Songs which originate from, or continue the musical tradition of the American Southern States.
NATION M:	Current popular music of the nation or region in that country’s language.
OLDIES:	Music from the so-called “golden age” of popular music.
FOLK M:	Music which has its roots in the musical culture of a particular nation.
DOCUMENT:	Programs concerning factual matters, presented in an investigative style.
TEST:	Broadcasts for testing emergency broadcast equipment or unit.
ALARM:	Emergency announcement.
NONE:	No program type, undefined program, or difficult to categorize into particular types.

Classification of the PTY codes for some FM stations may be different from the above list.

Switching to a Program of Your Choice Automatically



Another convenient RDS service is called “Enhanced Other Networks.”

This allows the receiver to switch temporarily to a broadcast program of your choice (TA, NEWS, and/or INFO) from a different source except in the following cases:

- When you are listening to a non-RDS station—all AM (MW) and some FM stations.
- When the last received FM station is a non-RDS station.
- When the receiver is in standby mode.

Before you start, remember...

- The Enhanced Other Networks function is only applicable to preset FM stations.
- You can use the Enhanced Other Networks function while listening to any source. However, to use the RDS operation buttons on remote control, the remote control operation mode must be set for the tuner operations mode (see page 31).

Press TA/NEWS/INFO repeatedly to select the program type(s) you want.

- Each time you press the button, the program type(s) change, and the corresponding indicators light up on the display.

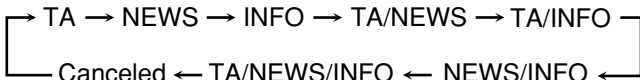

-
- TA:** Traffic Announcement in your area.
-
- NEWS:** News.
-
- INFO:** Program the purpose of which is to impart advice in the widest sense.
-

When the current source is “FM”

CASE 1 If the station currently tuned in starts broadcasting the program you have selected

The receiver continues to receive the station, but the indicator of received program type starts flashing.



When the program is over, the indicator of received program type stops flashing and remains lit, but the receiver remains in Enhanced Other Networks standby mode.

CASE 2 If another FM station starts broadcasting the program you have selected while you are listening to an FM station

The receiver automatically switches to the station. The indicator of received program type starts flashing.



When the program is over, the receiver goes back to the station previously tuned in, but still remains in Enhanced Other Networks standby mode. The indicator of received program type stops flashing and remains lit.

When the current source is other than “FM”

CASE 3 If a station starts broadcasting the program you have selected while listening to any source other than “FM”

When a station is or starts broadcasting the program you have selected, the receiver automatically switches to the station. The indicator of received program type starts flashing.



When the program is over, the receiver goes back to the previously selected source, but still remains in Enhanced Other Networks standby mode. The indicator of received program type stops flashing and remains lit.

To stop listening to the program selected by the Enhanced Other Networks function

Press TA/NEWS/INFO so that the program type (TA/NEWS/INFO) indicator stops flashing and remains lit. The unit enters the Enhanced Other Networks standby mode and goes back to the previously selected source.

If an “ALARM” (or TEST) signal is received from a station, the receiver automatically tunes in to the station.

- While receiving an emergency broadcast, “ALARM” appears on the display.

The TEST signal is used for testing the “ALARM” signal. Therefore, it makes the unit work in the same way as the “ALARM” signal does.

Notes:

- Enhanced Other Networks data sent from some stations may not be compatible with this receiver.
- While listening to a program tuned in by the Enhanced Other Networks function, you can only use the DISPLAY MODE and TA/NEWS/INFO buttons as the tuner operation buttons.
- While listening to a program tuned in by the Enhanced Other Networks function, you cannot change to another source or station. To change it, press TA/NEWS/INFO button first to cancel Enhanced Other Networks.

CAUTION:

When the source alternates intermittently between the station tuned in by the Enhanced Other Networks function and the currently selected source, press TA/NEWS/INFO repeatedly to cancel the Enhanced Other Networks function.

If you do not press the button, the currently tuned station is received finally, and one of the TA/NEWS/INFO indicators flashing on the display disappears.

Basic Settings

Some of the following settings are required after connecting and positioning your speakers while others will make operations easier. You can use QUICK SPEAKER SETUP to easily set up your speaker configuration.

Quick Speaker Setup



Quick Speaker Setup helps you to easily and quickly register the speaker size and speaker distance according to your listening room to create the best possible surround effect.

- You can also register each speaker's information manually. For details, see page 21.

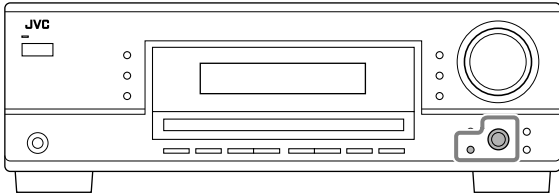

Before you start, remember...

There is a time limit in doing the following steps. If the setting is canceled before you finish, start from step 1 again.

1 Press QUICK SPEAKER SETUP.

“SPK→” and the initial speaker channel number (5.0CH) appear.

2 Turn MULTI JOG to select an appropriate number of the connected speakers (speaker channel number).

As you turn the jog, the speaker channel number changes as follows.

- For the details of speaker channel number, see “Speaker channel number and the size.”

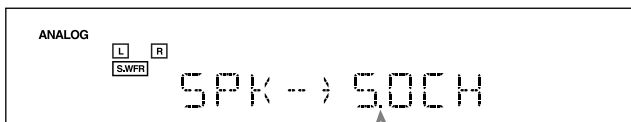

5.0CH ⇄ 5.1CH ⇄ 2.0CH ⇄ 2.1CH ⇄ 3.0CH ⇄ 3.1CH ⇄ 4.0CH ⇄ 4.1CH ⇄ (Back to the beginning)

3 Press in MULTI JOG (PUSH SET).

“ROOM SIZE→” and the initial room size setting appear.

4 Turn MULTI JOG to select an appropriate room size to match to your listening room.

As you turn the jog, the room size changes as follows.

- To select your appropriate room size, see “Room size and speaker distance/output level.”

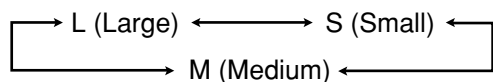
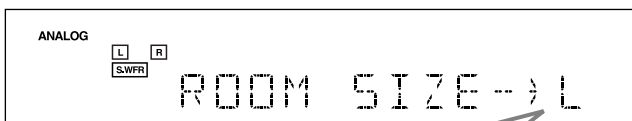

5 Press in MULTI JOG (PUSH SET).

“COMPLETE” appears on the display, then goes back to the source indication.

Note:

This procedure will not be completed if you stop in the middle of the setting process.

Speaker channel number and speaker size

You can find how each of the speaker size is defined according to the number of connected speakers (speaker channel “CH” number) you select.

- Subwoofer (S.WFR) is counted as 0.1 channel.

CH	The size of the connected speakers			
	L/R	C	LS/RS	S.WFR
2.0CH	LARGE	NONE	NONE	NO
2.1CH	SMALL	NONE	NONE	YES
3.0CH	LARGE	SMALL	NONE	NO
3.1CH	SMALL	SMALL	NONE	YES
4.0CH	LARGE	NONE	SMALL	NO
4.1CH	SMALL	NONE	SMALL	YES
5.0CH	LARGE	SMALL	SMALL	NO
5.1CH	SMALL	SMALL	SMALL	YES

Room size and speaker distance/output level

According to the selected room size, speaker distance and speaker output level for each activated speaker is set as follows:

Room size	Speaker	Distance	Output level
L (Large)	L/R	3.0 m (10 ft)	0 dB
	C	3.0 m (10 ft)	0 dB
	LS/RS	3.0 m (10 ft)	0 dB
M (Medium)	L/R	2.7 m (9 ft)	0 dB
	C	2.4 m (8 ft)	-2 dB
	LS/RS	2.1 m (7 ft)	-3 dB
S (Small)	L/R	2.4 m (8 ft)	0 dB
	C	2.1 m (7 ft)	-2 dB
	LS/RS	1.5 m (5 ft)	-4 dB

Notes:

- In the tables above, “L” stands for the left front speaker, “R” for the right front speaker, “C” for the center speaker, “LS” for the left surround speaker, “RS” for the right surround speaker, and “S.WFR” for the subwoofer.
- Once Quick Speaker Setup is performed, the speaker output levels are also set to appropriate values automatically (common to all sources). If you want to set the speaker output levels separately for each source, see “Adjusting the Speaker Output Levels” on page 25.

Basic Setting Items

On the following pages, you can adjust the following items:

- You can only select the items currently available. For details, see the explanation of each item.

Items	To do	See page
SUBWOOFER*	Register your subwoofer.	21
FRNT SPEAKERS*	Register your front speaker size.	21
CNTR SPEAKER*	Register your center speaker size.	21
SURR SPEAKERS*	Register your surround speaker size.	21
DISTANCE UNIT	Select the measuring unit for the speaker distance.	21
FRONT L DIST*	Register the distance from the left front speaker to your listening point.	21
FRONT R DIST*	Register the distance from the right front speaker to your listening point.	21
CENTER DIST*	Register the distance from the center speaker to your listening point.	21
SURR L DIST*	Register the distance from the left surround speaker to your listening point.	21
SURR R DIST*	Register the distance from the right surround speaker to your listening point.	21
SUBWOOFER OUT	Select the type of the sounds emitted from the subwoofer.	21
CROSSOVER	Select the cutoff frequency to the subwoofer.	22
LFE ATTENUATE	Attenuate the bass (LFE) sounds.	22
MIDNIGHT MODE	Reproduce a powerful sound at night.	22
DUAL MONO	Select the Dual Mono sound channel.	22
AUTO SURROUND	Turn on or off Auto Surround.	23
VIRTUAL SBACK	Turn on or off Virtual Surround Back.	23
DIGITAL IN	Select the component connected to digital input terminal.	23

Note:

* These items can be set using Quick Speaker Setup (see page 19).

Basic Procedure

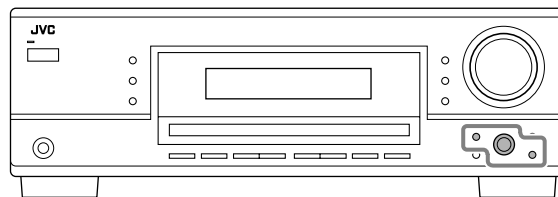

Before you start, remember...

There is a time limit in doing the following steps. If the setting is canceled before you finish, start from step 1 again.

Ex. When setting Auto Surround to “AUTO SURR ON.”

1 Press SETTING.

The last selected item appears on the display.

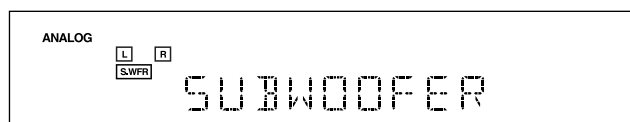

2 Turn MULTI JOG until an item you want appears on the display.

- In this example, select “AUTO SURROUND.” For available items, see the list “Basic Setting Items.”

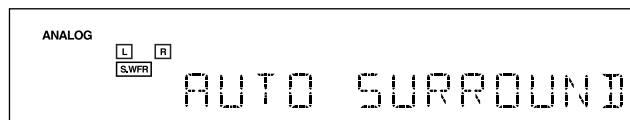

3 Press in MULTI JOG (PUSH SET).

The current setting for the selected item appears on the display.

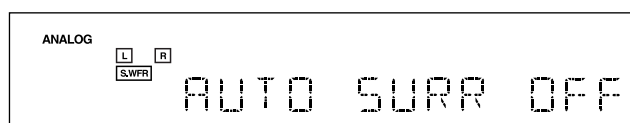

4 Turn MULTI JOG until a setting you want appears on the display.

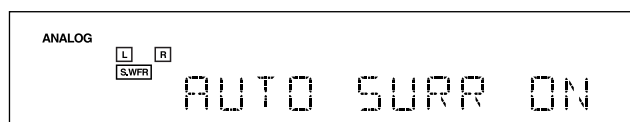

5 Press in MULTI JOG (PUSH SET).

6 Repeat steps 2 to 5 to set other items if necessary.

7 Press EXIT.

The source indication resumes on the display.

Setting the Speakers

To obtain the best possible surround effect from the Surround and DSP modes, register the setting about the speaker arrangement after all connections are completed.

- If you have used Quick Speaker Setup on page 19, this setting is not required.

Subwoofer setting—SUBWOOFER

Select whether you have connected a subwoofer or not.

SUBWOOFER YES: Select when a subwoofer is connected.

SUBWOOFER NO: Select when no subwoofer is used.

Note:

If you have selected "SUBWOOFER NO" for the subwoofer, you cannot use the SUBWOOFER OUT ON/OFF button on the front panel.

Speaker size—FRNT SPEAKERS, CNTR SPEAKER, SURR SPEAKERS

Select the size for each connected speaker.

LARGE: Select when the speaker size is relatively large.

SMALL: Select when the speaker size is relatively small.

NONE: Select this when you have not connected a speaker. (Not selectable for the front speakers)

Notes:

- Keep the following comments in mind as reference when adjusting.
 - If the size of the cone speaker unit built in your speaker is larger than 12 cm, select "LARGE," and if it is smaller than 12 cm, select "SMALL."
- If you have selected "SUBWOOFER NO" for the subwoofer setting, you can only select "LARGE" for the front speakers.
- If you have selected "SMALL" for the front speakers, you cannot select "LARGE" for the center and surround speakers.

Setting the Speaker Distance

The distance from your listening point to the speakers is another important element to obtain the best possible sound of the Surround and DSP modes. Set the distance from your listening point to the speakers.

By referring to the speaker distance setting, this unit automatically sets the delay time of the sound through each speaker so that sounds through all the speakers can reach you with the same timing.

- If you have used Quick Speaker Setup on page 19, this setting is not required.

Measuring unit—DISTANCE UNIT

Select which measuring unit you use.

UNIT METER: Select to set the distance in meters.

UNIT FEET: Select to set the distance in feet.

Speaker distance—FRONT L DIST, FRONT R DIST, CENTER DIST, SURR L DIST, SURR R DIST

Set the distance from the listening point within the range of 0.3 m (1 ft) to 9.0 m (30 ft), in 0.3 m (1 ft) intervals.

- When shipped from the factory, distance for each speaker is set to "3.0m (10FT)."

Note:

You cannot set the speaker distance for the speakers you have selected "NONE."

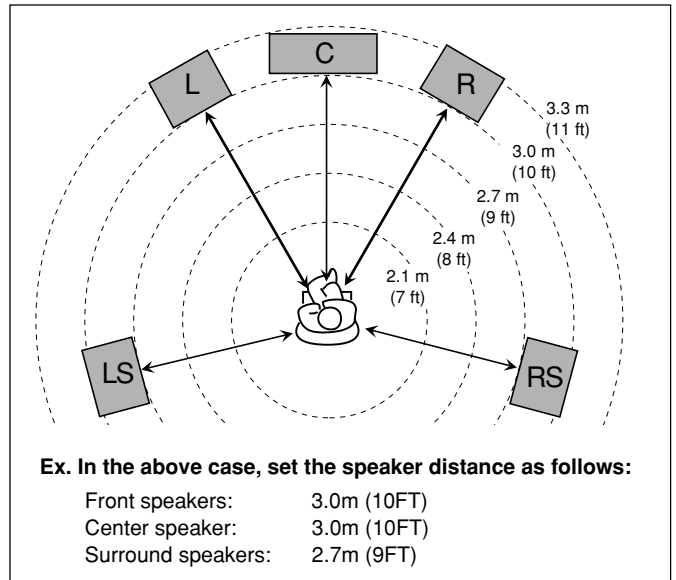

Setting the Bass Sounds

You can adjust subwoofer and bass sounds precisely according to your preference.

Subwoofer output—SUBWOOFER OUT

You can select the type of the signal which can be transmitted through the subwoofer. In other words, you can determine whether or not the bass elements of the front speaker channels are transmitted through the subwoofer regardless of the front speaker size setting (either "SMALL" or "LARGE").

Select one of the following:

SWFR LFE: Select to emit only the LFE signals (while playing Dolby Digital and DTS software) or the bass elements of the "SMALL" front speakers (while playing any source other than the above).

SWFR LFE+MAIN: Select to always emit the bass elements of the front speaker channels (MAIN). While playing Dolby Digital and DTS software, the bass element and the LFE signals are both emitted.

Note:

If you have selected "SUBWOOFER NO" for the subwoofer, this function is not available.

Basic Settings

● **Crossover frequency—CROSSOVER**

You can select the crossover frequency for the small speakers used. The signals below the preset frequency level will be sent to and be reproduced by the subwoofer (or by "LARGE" speakers when "SUBWOOFER" is set to "SUBWOOFER NO").

Select one of the crossover frequency levels according to the size of the small speaker connected.

CROSS 80HZ: Select when the cone speaker unit built in the speaker is about 12 cm.

CROSS 100HZ: Select when the cone speaker unit built in the speaker is about 10 cm.

CROSS 120HZ: Select when the cone speaker unit built in the speaker is about 8 cm.

CROSS 150HZ: Select when the cone speaker unit built in the speaker is about 6 cm.

CROSS 200HZ: Select when the cone speaker unit built in the speaker is about 5 cm.

Notes:

- If you have selected "LARGE" for all activated speakers (see page 21), this function is fixed to "CROSS OFF."
- Crossover frequency is not valid for "HEADPHONE" and "3D H PHONE."

● **Low frequency effect attenuator—LFE ATTENUATE**

If the bass sound is distorted while playing back software encoded with Dolby Digital or DTS, set the LFE level to eliminate distortion.

- This function takes effect only when the LFE signals come in.

Select one of the following:

LFE ATT 0dB: Normally select this.

LFE ATT -10dB: Select when the bass sound is distorted.

● **Midnight mode—MIDNIGHT MODE**

You can enjoy a powerful sound at night using Midnight Mode.

Select one of the following:

MIDNIGHT 1: Select when you want to reduce the dynamic range a little.

MIDNIGHT 2: Select when you want to apply the compress effect fully (useful at midnight).

MIDNIGHT OFF: Select when you want to enjoy playback with its full dynamic range (no effect applied).

■ **Selecting the Main or Sub Channel**

You can select the playback sound (channel) you want while playing digital software recorded (or broadcast) in Dual Mono mode (see page 27), which includes two monaural channels separately.

● **Dual Mono—DUAL MONO**

Select the playback sounds (channel).

MONO MAIN: Select to play back the main channel (Ch 1).*
Signal indicator "L" lights up while playing back this channel.

MONO SUB: Select to play back the sub-channel (Ch 2).*
Signal indicator "R" lights up while playing back this channel.

MONO ALL: Select to play back both the main and sub-channels (Ch 1/Ch 2).*
Signal indicators "L" and "R" light up while playing back these channels.

Notes:

- The Dual Mono format is not identical with bilingual broadcasting or the MTS (Multichannel Television Sound) format used for TV programs. So this setting does not take effect while watching bilingual or MTS programs.
- * Dual Mono signals can be heard from the following speakers—L (left front speaker), R (right front speaker), and C (center speaker)—with respect to the current Surround setting.

Dual Mono Setting	Without Surround		With Surround Activated				
			Center speaker setting				
	L	R	SMALL/LARGE		NONE		
MAIN	Ch 1	Ch 1	—	Ch 1	—	Ch 1	Ch 1
SUB	Ch 2	Ch 2	—	Ch 2	—	Ch 2	Ch 2
ALL	Ch 1	Ch 2	—	Ch 1+Ch 2	—	Ch 1+Ch 2	Ch 1+Ch 2

■ Setting for Easy and Effective Surround Operations

● Auto Surround—AUTO SURROUND

Auto Surround works when the unit detects the incoming digital signal. In other words, it works...

- When you select the digital source (the source with digital input selected for it), and
- When you change the input mode from analog to digital.

Select “**AUTO SURR ON**” to activate Auto Surround.

AUTO SURR ON:

- When multi-channel signal is detected, an appropriate Surround mode will be turned on.
- When Dolby Digital 2-channel with surround signals is detected, “PLII MOVIE” will be selected.
- When Dolby Digital 2-channel without surround signals is detected, “SURROUND OFF” will be selected.
- When Linear PCM signal is detected, nothing will change.

AUTO SURR OFF: Select to deactivate Auto Surround.

Notes:

- This function does not take effect in the following cases:
 - While playing an analog source,
 - While selecting any of DSP modes (see page 29), or one of the fixed digital input mode—“DOLBY DIGITAL” or “DTS SURROUND” (see page 12), and
 - While listening with the headphones—“HEADPHONE” or “3D H PHONE” (see pages 11 and 27).
- If you select another Surround mode or DSP mode (or deactivate the Surround/DSP mode) manually, Auto Surround, if in use, will be canceled temporarily for the currently selected source. Auto Surround setting will be restored in the following cases:
 - When you turn the receiver off and on,
 - When you change the source,
 - When you change the analog/digital input, and
 - When you select “AUTO SURR ON” again.

● Virtual Surround Back—VIRTUAL SBACK

You can enjoy the surround back channel while playing back Dolby Digital Surround EX software or DTS-ES software without the surround back speakers. This function creates the great surround effect from the behind as if you have connected the surround back speakers.

Select “**VRTL SB ON**” to activate Virtual Surround Back.

VRTL SB ON: While you play Dolby Digital Surround EX software or DTS-ES software, the VIRTUAL SB (Surround Back) indicator lights up.

VRTL SB OFF: Select to deactivate Virtual Surround Back.

Notes:

- When you have set “NONE” for “SURR SPEAKERS,” this function is not available.
- While playing back DTS-ES Matrix software with DTS 96/24, DTS 96/24 processing will not be performed with Virtual Surround Back activated. To apply the processing, deactivate Virtual Surround Back.
- Virtual Surround Back may not be applied to some software.
- Virtual Surround Back only works for Surround modes (see page 28). This function does not work when activating the DSP mode (see page 30).

■ Setting the Digital Input Terminals

When you use the digital input terminals, register which components you have connected to the digital input terminals.

● Digital Input terminal—DIGITAL IN

Set the components connected to the digital terminals.

- As you rotate MULTI JOG, the digital input terminals are set to used for the following digital components:

1DVD	2CD	⇄	1DVD	2TV	⇄	1DVD	2CDR	⇄
1CD	2DVD	⇄	1CD	2TV	⇄	1CD	2CDR	⇄
1TV	2DVD	⇄	1TV	2CD	⇄	1TV	2CDR	⇄
1CDR	2DVD	⇄	1CDR	2CD	⇄	1CDR	2TV	⇄

(back to the beginning)

Adjusting Sound

You can make sound adjustment to your preference after completing basic settings.

Basic Adjustment Items

On the following pages, you can adjust the following items:

- You can adjust only the items applicable to the current sound mode.

Items	To do	See page
DEQ 63HZ	Adjust equalizer pattern at 63 Hz.	25
DEQ250HZ	Adjust equalizer pattern at 250 Hz.	25
DEQ 1KHZ	Adjust equalizer pattern at 1 kHz.	25
DEQ 4KHZ	Adjust equalizer pattern at 4 kHz.	25
DEQ16KHZ	Adjust equalizer pattern at 16 kHz.	25
SUBWFR LEVEL	Adjust the subwoofer output level.	25
FRONT L LEVEL	Adjust the left front speaker output level.	25
FRONT R LEVEL	Adjust the right front speaker output level.	25
CENTER LEVEL	Adjust the center speaker output level.	25
SURR L LEVEL	Adjust the left surround speaker output level.	25
SURR R LEVEL	Adjust the right surround speaker output level.	25
EFFECT* ¹	Adjust the effect level.	25
PANORAMA CTRL* ²	Add “wraparound” sound effect with side-wall image.	25

Notes:

*¹ Adjustable when one of the DAP modes or Mono Film (see pages 29 and 30) is in use.

*² Adjustable when Pro Logic II Music is in use.

Basic Procedure

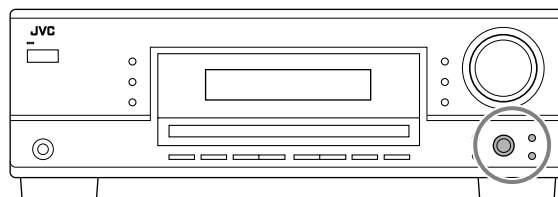

Before you start, remember...

There is a time limit in doing the following steps. If the setting is canceled before you finish, start from step 1 again.

Ex. When adjusting the subwoofer level to “-3.”

1 Press ADJUST.

The last selected item appears on the display.

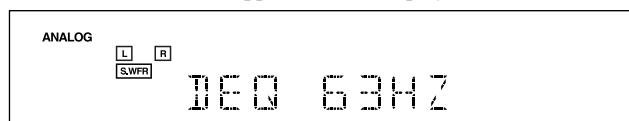

2 Turn MULTI JOG until an item you want appears on the display.

- In this example, select “SUBWFR LEVEL.” For available items, see the list “Basic Adjustment Items.”

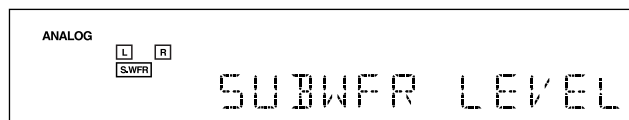

3 Press in MULTI JOG (PUSH SET).

The current setting (or level) for the selected item appears on the display.

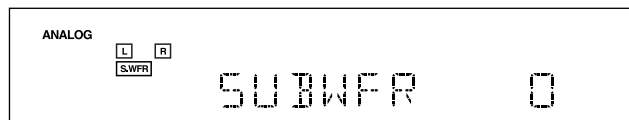

4 Turn MULTI JOG to select a setting you want or to make an adjustment as you like.

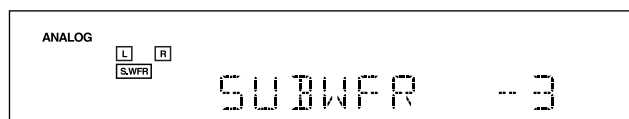

5 Press in MULTI JOG (PUSH SET).

6 Repeat steps 2 to 5 to set other items if necessary.

7 Press EXIT.

The source indication resumes on the display.

Adjusting the Equalization Patterns

You can adjust the equalization patterns to your preference.

- Once you have made adjustment, it is memorized for each source.

- **Equalization adjustment**—DEQ 63HZ, DEQ250HZ, DEQ 1KHZ, DEQ 4KHZ, DEQ16KHZ

You can adjust five frequencies (63 Hz, 250 Hz, 1 kHz, 4 kHz, 16 kHz) within the range of -8 dB to $+8$ dB in 2 dB steps.

- When adjustment is made, the DIGITAL EQ indicator lights up on the display.

To flat the equalization pattern, set all the frequencies to “0 (0 dB)” in step 4 of “Basic Procedure” (on page 24). The DIGITAL EQ indicator goes off from the display.

Note:

The equalization patterns affect the front speaker sounds only.

Adjusting the Speaker Output Levels

You can adjust the speaker output levels.

- Once you have made adjustment, it is memorized for each source.

- **Adjustable speakers**—SUBWFR LEVEL, FRONT L LEVEL, FRONT R LEVEL, CENTER LEVEL, SURR L LEVEL, SURR R LEVEL

You can adjust the connected speakers’ output levels within the range of -10 dB to $+10$ dB.

Note:

If you have deactivated a speaker (see page 21), the output level adjustment for the speaker is not adjustable.

Adjusting the Sound Parameters for the Surround and DSP Modes

You can adjust the Surround and DSP sound parameters to your preference. (For Surround and DSP modes, see pages 26 and 29.)

- **Adjustable parameters**

You can adjust the following parameters:

For DAP modes and Mono Film

- Once you have made adjustment, it is memorized for each mode.

EFFECT: Adjust the effect level. As the number increases, the effect becomes stronger.
(Adjustable range: 1 to 5. Normally select “3.”)

For Pro Logic II Music only

PANORAMA CTRL: Select “PANORAMA ON” to add “wraparound” sound effect with side-wall image.
• To cancel it, select “PANORAMA OFF.”

You can also use the remote control for adjusting the speaker output level using the test tone.

- You can also adjust the effect level for DAP modes and Mono Film.

To adjust the speaker output level:

1 Press SOUND.

The 10 keys are activated for sound adjustments.

2 Press TEST to check if you can

hear the sounds through all the speakers at equal level.

Test tone (TEST TONE) comes out of the speakers in the following order.

- No test tone comes out of the speakers for which the speaker setting is set to “NONE” (or “SUBWOOFER NO” for the subwoofer).

L (Left front) → C (Center) → R (Right front) →
RS (Right surround) → LS (Left surround) →
SW (Subwoofer) → (Back to the beginning)

3 Adjust the speaker output level (-10 dB to $+10$ dB).

- For the left front speaker: Press FRONT L, then LEVEL +/-.
- For the center speaker: Press CENTER, then LEVEL +/-.
- For the right front speaker: Press FRONT R, then LEVEL +/-.
- For the right surround speaker: Press SURR R, then LEVEL +/-.
- For the left surround speaker: Press SURR L, then LEVEL +/-.
- For the subwoofer: Press SUBWFR, then LEVEL +/-.

Note:

When you press LEVEL +/- once, the current level for the selected speaker appears on the display, and the test tone comes out of the selected speaker.
If no adjustment is done for about 4 seconds, the adjustment mode for the selected speaker is canceled.

4 Press TEST again to stop the test tone.

To adjust the effect level:

1 Press SOUND.

The 10 keys are activated for sound adjustments.

2 Press EFFECT repeatedly to select the effect level (EFFECT 1 to EFFECT 5).

The source indication resumes about 4 seconds after the adjustment.

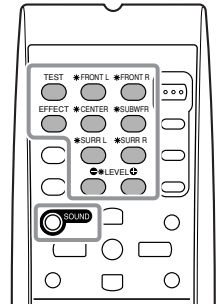

Using the Surround Modes

This unit activates a variety of Surround modes automatically. The basic settings and adjustments stored (see pages 19 to 25) are applied automatically.

Reproducing Theater Ambience

In a movie theater, many speakers are located on the walls to reproduce impressive multi-surround sounds, reaching you from all directions.

With these many speakers, sound localization and sound movement can be expressed.

Surround modes built in this receiver can create almost the same surround sounds as you can feel in a real movie theater—with only a limited number of the speakers.

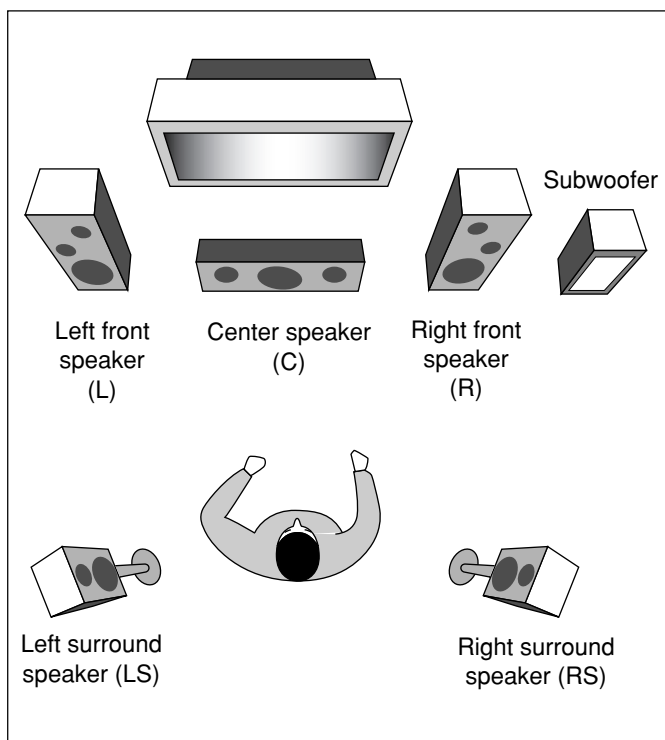
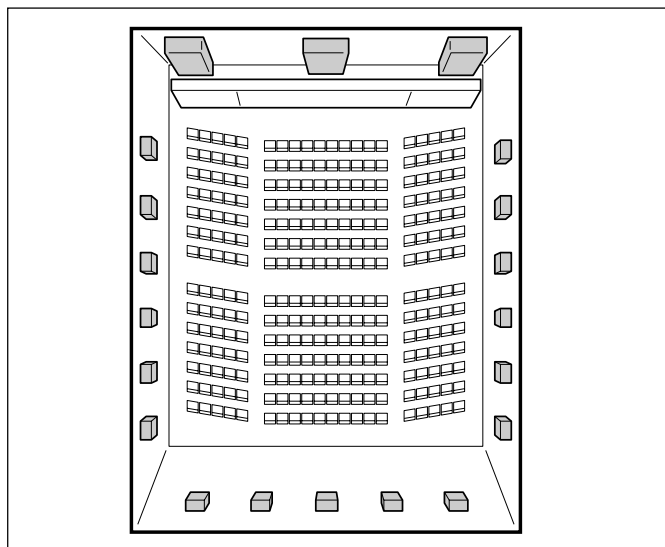

Introducing the Surround Modes

Dolby Digital*¹

Dolby Digital is a digital signal compression method, developed by Dolby Laboratories, and enables multi-channel encoding and decoding (1ch up to 5.1ch).

- When Dolby Digital signal is detected through the digital input, the  **DIGITAL** indicator lights up on the display.

Dolby Digital 5.1CH

Dolby Digital 5.1CH (DOLBY DIGITAL) encoding method records and digitally compresses the left front channel, right front channel, center channel, left surround channel, right surround channel, and LFE channel signals (total 6 channels, but the LFE channel is counted as 0.1 channel. Therefore, called 5.1 channel). Dolby Digital enables stereo surround sounds, and sets the cutoff frequency of the surround treble at 20 kHz, compared to 7 kHz for Dolby Pro Logic. As such, the sound movement and “being-there” feeling are enhanced much more than Dolby Pro Logic.

Another digital surround encoding format introduced by Dolby Laboratories is **Dolby Digital EX**, which adds the third surround channels, called “surround back.”

Compared to the conventional Dolby Digital 5.1CH, these newly added surround back channels can reproduce more detailed movements behind you while viewing the video software. In addition, surround sound localization will become more stable.

- You can use Virtual Surround Back (see page 23) when playing back Dolby Digital Surround EX software. This function creates the great surround effect from the behind as if you have connected the surround back speakers.

Dolby Pro Logic II

Dolby Pro Logic II is a multi-channel playback format to convert 2-channel software into 5-channel (plus subwoofer). The matrix-based conversion method used for Dolby Pro Logic II makes no limitation for the cutoff frequency of the surround treble and enables stereo surround sound.

- This receiver provides two types of Dolby Pro Logic II modes—**Pro Logic II Movie** (PLII MOVIE) and **Pro Logic II Music** (PLII MUSIC).

When Dolby Pro Logic II is activated, the  **PRO LOGIC II** indicator lights up on the display.

PLII MOVIE: Suitable for playing any Dolby Surround encoded software. You can enjoy a sound field very close to the one created with discrete 5.1-channel sounds.

PLII MUSIC: Suitable for playing any 2-channel stereo software. You can enjoy wide and deep sounds.

DTS*2

DTS is another digital signal compression method, developed by Digital Theater Systems, Inc., and enables multi-channel encoding and decoding (1ch up to 6.1ch).

- When DTS signal is detected through the digital input, the  indicator lights up on the display.

DTS Digital Surround

DTS Digital Surround (DTS SURROUND) is another discrete 5.1-channel digital audio format available on CD, LD, and DVD software.

Compared to Dolby Digital, the DTS Digital Surround format has a lower audio compression rate which enables it to add breadth and depth to the sounds reproduced. As such, DTS Digital Surround features natural, solid, and clear sound.

Another multi-channel digital encoding format introduced by Digital Theater Systems, Inc. is **DTS Extended Surround (DTS-ES)**.

It greatly improves the 360-degree surround impression and space expression by adding the third surround channel—surround back channel.

DTS-ES includes two signal formats with different surround signal recording methods—**DTS-ES Discrete 6.1ch** and **DTS-ES Matrix 6.1ch**.

- You can use Virtual Surround Back (see page 23) when playing back DTS-ES software. This function creates the great surround effect from the behind as if you have connected the surround back speakers.

DTS 96/24

In recent years, there has been increasing interest in higher sampling rates both for recording and for reproducing at home. Higher sampling rates allow wider frequency range and greater bit depths provide extended dynamic range.

DTS 96/24 is a multi-channel digital signal format (fs 96 kHz/24 bits) introduced by Digital Theater Systems, Inc. to deliver “better-than-CD sound quality” into the home.

- When DTS 96/24 signal is detected, the  96/24 indicator lights up. You can enjoy its 5.1-channel sound with full-quality.

What is Linear PCM?

Uncompressed digital audio data used for DVDs, CDs and Video CDs.

DVDs support 2 channels with sampling rates of 48/96 kHz, at quantization of 16/20/24 bits. On the other hand, CDs and Video CDs are limited to 2 channels with 44.1 kHz at 16 bits.

- When Linear PCM signal is detected, the **LINEAR PCM** indicator lights up.

What is Dual Mono?

Dual Mono can be easily understood when you think of the bilingual broadcast or the MTS (Multichannel Television Sound) format used for TV programs (however, the Dual Mono format is not identical with those analog formats).

This format is now adopted in Dolby Digital, DTS, and so on. It allows two independent channels (called main channel and sub-channel) to be recorded separately.

- When Dual Mono signal is detected, the **DUAL MONO** indicator lights up. You can select either channel you want to listen to (see page 22).

When using the Surround mode, the sounds come out of the activated speakers which the Surround mode requires.

- If either the surround speakers or center speaker is set to “NONE” in the speaker setting, the corresponding channel signals are allocated to and emitted through the front speakers.
- If both the surround speakers and center speaker are set to “NONE” in the speaker setting, JVC’s original 3D-PHONIC processing (which has been developed to create the surround effect through the front speakers only) is used. The 3D-PHONIC indicator lights up on the display.

3D Headphone Mode—3D H PHONE

If you activate Surround when the front speakers are deactivated, 3D Headphone Mode is activated without respect to the type of software played back. “3D H PHONE” appears on the display and the DSP and H.PHONE indicators also light up.

*1 Manufactured under license from Dolby Laboratories. “Dolby”, “Pro Logic”, and the double-D symbol are trademarks of Dolby Laboratories.

*2 “DTS” and “DTS 96/24” are trademarks of Digital Theater Systems, Inc.

Using the Surround Modes

Activating the Surround Modes

Available Surround modes vary depending on the incoming signals.

Activating one of the Surround modes for a source automatically recalls the memorized settings and adjustments (see pages 19 to 25).

Activating the Surround Modes Automatically

You can enjoy the Surround mode simply by selecting the source (with digital input selected for that source).

- Auto Surround also works when the input mode changes from analog to digital.

To activate Auto Surround, see page 23.

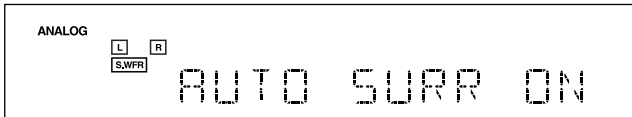

Activating the Surround Modes Manually

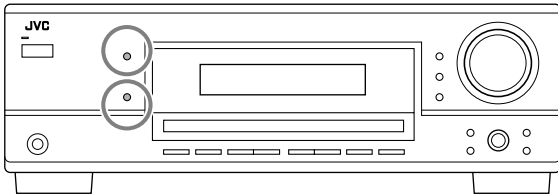

1 Select and play any source.

- Make sure you have selected the analog or digital input mode correctly.

2 Press SURROUND to activate the Surround mode.

- For Dolby Digital multi-channel digital software (except 2-channel and Dual Mono software), incoming signals are automatically detected and “DOLBY DIGITAL” is activated.

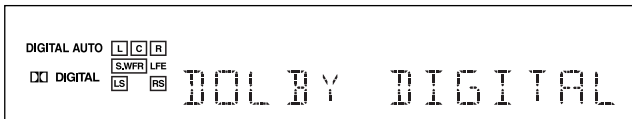

- For DTS multi-channel digital software (except 2-channel and Dual Mono software), incoming signals are automatically detected and “DTS SURROUND” is activated.

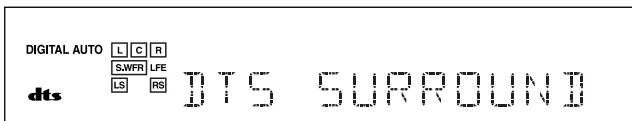

Note:

When the Dolby Digital or DTS multi-channel digital signal stops coming in, “PLII MOVIE” will be activated.

- For analog sources and digital 2-channel software, you can select one of the following Surround modes. Each time you press SURROUND, Surround modes change as follows:

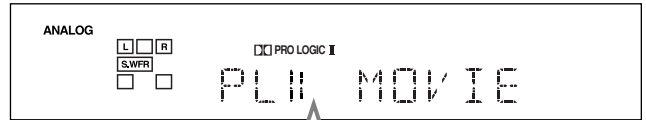

- For Dual Mono software, you can select the channel you listen to. (See page 22.)

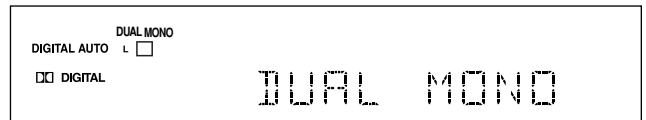

To adjust the speaker output level, see page 25.

To cancel the Surround mode

Press SURROUND/DSP OFF.

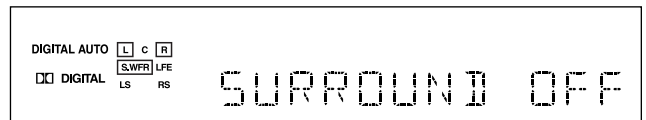

When playing Dolby Digital Surround EX or DTS-ES software

You can enjoy Virtual 6.1-channel playback using Virtual Surround Back.

To activate Virtual Surround Back, see page 23.

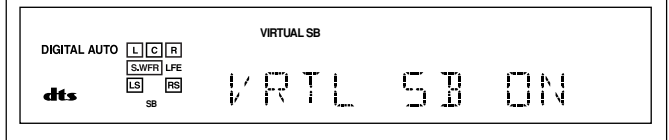

Using the DSP Modes

This unit activates a variety of DSP modes automatically. The basic settings and adjustments stored (see pages 19 to 25) are applied automatically.

Reproducing the Sound Field

The sound heard in a concert hall, club, etc. consists of direct sound and indirect sound—early reflections and reflections from behind. Direct sounds reach the listener directly without any reflection. On the other hand, indirect sounds are delayed by the distances of the ceiling and walls. These direct sounds and indirect sounds are the most important elements of the acoustic surround effects. DSP modes can create these important elements, and give you a real “being there” feeling.

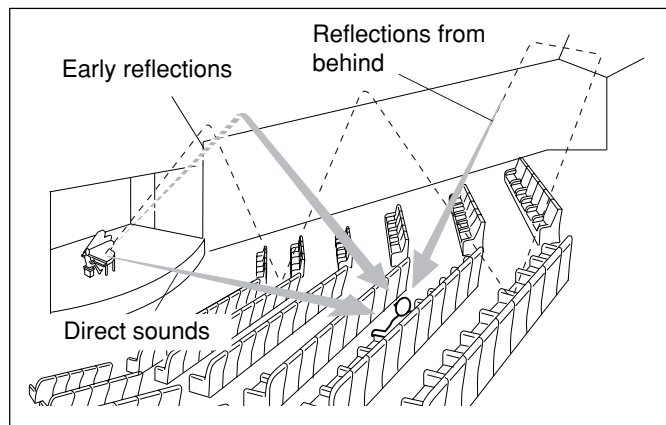

Introducing the DSP Modes

DSP modes include the following modes—

- Digital Acoustic Processor (DAP) modes—HALL 1, HALL 2, LIVE CLUB, DANCE CLUB, PAVILION, THEATER 1, THEATER 2
- ALL CH STEREO
- MONO FILM—Used for all types of 2-channel signals (including Dual Mono signal)

3D Headphone Mode—3D H PHONE

If you press DSP when the front speakers are deactivated, 3D Headphone Mode is activated without respect to the type of software played back. “3D H PHONE” appears on the display and the DSP and H.PHONE indicators light up.

To use DSP modes, press DSP so that the DSP modes change as follows.

The DSP indicator also lights up on the display.

→ HALL 1	→ HALL 2	→ LIVE CLUB
→ DANCE CLUB	→ PAVILION	→ ALL CH STEREO
→ THEATER 1	→ THEATER 2	→ MONO FILM

→ (Back to the beginning)

- : Suitable for audio sources
- : Suitable for video sources

Digital Acoustic Processor (DAP) modes

You can use the following DAP modes in order to reproduce a more acoustic sound field in your listening room.

-
- HALL 1:** Reproduces the spatial feeling of a large shoebox-shaped hall designed primarily for classical concerts. (Its seating capacity is about 2000.)
-
- HALL 2:** Reproduces the spatial feeling of a large vineyard-shaped hall designed primarily for classical concerts. (Its seating capacity is about 2000.)
-
- LIVE CLUB:** Reproduces the spatial feeling of a live music club with a low ceiling.
-
- DANCE CLUB:** Reproduces the spatial feeling of a rocking dance club.
-
- PAVILION:** Reproduces the spatial feeling of an exhibition hall with a high ceiling.
-
- THEATER 1*:** Reproduces the spatial feeling of a large theater where the seating capacity is about 600.
-
- THEATER 2*:** Reproduces the spatial feeling of a small theater where the seating capacity is about 300.

* The built-in Dolby Pro Logic II decoder is activated when playing back 2-channel analog or digital source. The PRO LOGIC II indicator lights up.

When using the DAP mode, the sounds come out of all the connected and activated speakers.

- If surround speakers are set to “NONE” in the speaker setting, JVC’s original 3D-PHONIC processing (which has been developed to create the surround effect through the front speakers only) is used. The 3D-PHONIC indicator lights up on the display.

Continued on the next page

Using the DSP Modes

All Channel Stereo

This mode can reproduce a larger stereo sound field using all the connected (and activated) speakers.

- If the surround speakers are set to “NONE,” you cannot select “ALL CH STEREO.”

Sound reproduced from normal stereo

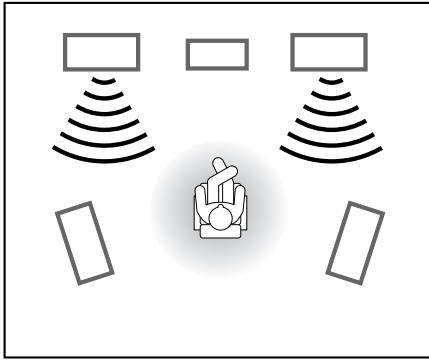

Sound reproduced from All Channel Stereo mode

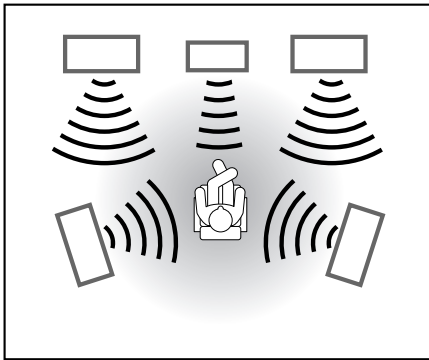

Mono Film

In order to reproduce a more acoustic sound field in your listening room while viewing monaural sound video software (analog and 2-channel digital signals), you can use this mode.

The surround effect will be added, and the sound localization of actor’s words will be improved. **This mode cannot be used for multi-channel digital signals.**

When “MONO FILM” is used, the sounds come out of all the connected and activated speakers.

- If surround speakers are set to “NONE” in the speaker setting, JVC’s original 3D-PHONIC processing (which has been developed to create the surround effect through the front speakers only) is used. The 3D-PHONIC indicator lights up on the display.
- If incoming signals change from 2-channel digital signal to another digital signal type, “MONO FILM” is canceled and an appropriate Surround mode is activated.

Activating the DSP Modes

Activating one of the DSP modes for a source automatically recalls the memorized settings and adjustments (see pages 19 to 25).

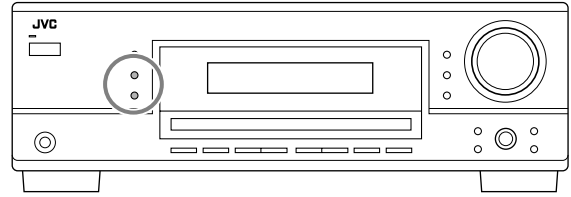

- 1 Select and play any source.
- 2 Press DSP repeatedly until the DSP mode you want appears on the display.
 - Each time you press the button, the DSP modes change as follows:

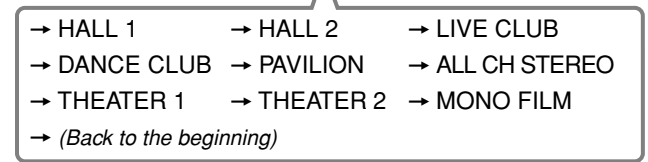
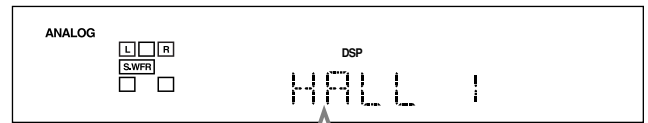

Note:

When the surround speakers are set to “NONE,” the 3D-PHONIC processing is applied to the DSP modes (the 3D-PHONIC indicator also lights up).

To adjust the effect level (except All Channel Stereo), see page 25.

To cancel the DSP mode

Press SURROUND/DSP OFF.

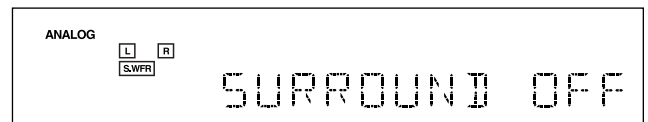

Operating JVC's Audio/Video Components

You can operate JVC's audio and video components with this receiver's remote control, since control signals for JVC's components are preset in the remote control.

IMPORTANT:

To operate JVC's audio and video components using the supplied remote control:

- When using the remote control, aim the remote control directly at the remote sensor on each component, not on the receiver.
- Refer also to the manuals supplied with your components.
- Some JVC's VCRs can accept two types of the control signals—remote code "A" and "B." Before using this remote control, make sure that the remote control code of the target VCR is set to code "A."

Operating Audio Components

Sound control section (Amplifier)

You can always perform the following operations:

STANDBY/ON \odot /I AUDIO:

Turn on or off the receiver.

VOLUME +/-:

Adjust the volume level.

MUTING:

Turn on or off sound muting.

ANALOG/DIGITAL:

Switch the analog and digital input alternately.

DIMMER:

Dim or brighten the display.

SLEEP:

Set the Sleep Timer.

SURROUND:

Turn on and select Surround modes.

DSP:

Turn on and select DSP modes.

SURROUND/DSP OFF:

Turn off the Surround and DSP mode.

After pressing SOUND, you can perform the following operations by using the 10 keys:

FRONT L then LEVEL +/-: Adjust the left front speaker output level.

FRONT R then LEVEL +/-: Adjust the right front speaker output level.

CENTER then LEVEL +/-: Adjust the center speaker output level.

SURR L then LEVEL +/-: Adjust the left surround speaker output level.

SURR R then LEVEL +/-: Adjust the right surround speaker output level.

SUBWFR then LEVEL +/-: Adjust the subwoofer output level.

EFFECT: Adjust the effect level.

TEST: Turn on or off test tone output.

Note:

After adjusting sounds, press the corresponding source selection button to operate your target source by using the 10 keys; otherwise, the 10 keys cannot be used for operating your target source.

Tuner

You can always perform the following operations:

FM/AM: Alternate between FM and AM.

After pressing FM/AM, you can perform the following operations on a tuner:

1 – 10, +10: Select a preset channel number directly.

For channel number 5, press 5.

For channel number 15, press +10, then 5.

For channel number 20, press +10, then 10.

PTY SEARCH: Search for a program by PTY codes.

PTY \oplus , \ominus PTY: Select the PTY codes.

DISPLAY MODE: Show the RDS signals.

TA/NEWS/INFO: Select the Enhanced Other Networks data type (TA, NEWS, INFO).

FM MODE: Change the FM reception mode.

CD player

After pressing CD, you can perform the following operations on a CD player:

\blacktriangleright : Start playing.

$\blacktriangleleft\blacktriangleleft$: Return to the beginning of the current (or previous) track.

$\blacktriangleright\blacktriangleright$: Skip to the beginning of the next track.

\blacksquare : Stop playing.

\parallel : Pause playing. To resume, press \blacktriangleright .

1 – 10, +10: Select a track number directly.

For track number 5, press 5.

For track number 15, press +10, then 5.

For track number 20, press +10, then 10.

For track number 30, press +10, +10, then 10.

Operating JVC's Audio/Video Components

CD changer

After pressing CD-DISC, you can perform the following operations on a CD changer:

- ▶: Start playing.
- ◀◀: Return to the beginning of the current (or previous) track.
- ▶▶: Skip to the beginning of the next track.
- : Stop playing.
- ||: Pause playing. To resume, press ▶.
- 1 – 6, 7/P: Select the number of a disc installed in a CD changer.

After pressing CD, you can perform the following operations on a CD changer:

- 1 – 10, +10: Select a track number directly.
For track number 5, press 5.
For track number 15, press +10, then 5.
For track number 20, press +10, then 10.
For track number 30, press +10, +10, then 10.

Example:

- Selecting disc number 4, track number 12, and starting playback.
 - 1 Press CD-DISC, then press 4.
 - 2 Press CD, then press +10, 2.

If your CD changer is of 200-disc loading capability (except for XL-MC100 and XL-MC301), you can do the following operations using the 10 keys after pressing CD.

- 1 Select a disc number.
- 2 Then select a track number (always enter two digits).
- 3 Press ▶ to start playback.

Examples:

- Selecting disc number 3, track number 2, and starting playback.
Press 3, then, 0, 2, then ▶.
- Selecting disc number 10, track number 5, and starting playback.
Press 1, 0, then, 0, 5, then ▶.
- Selecting disc number 105, track number 12, and starting playback.
Press 1, 0, 5, then 1, 2, then ▶.

Note:

It is required to press each button within 4 seconds in the above procedure.

Operating Video Components

VCR

You can always perform the following operations:

- STANDBY/ON \odot /I VCR: Turn on or off the VCR.
- VCR CH +/-: Change the TV channels on the VCR.

After pressing VCR, you can perform the following operations on the VCR:

- ▶: Start playing.
- REW: Rewind the tape.
- FF: Fast-forward the tape.
- : Stop playing, recording, rewind and fast forward.
- ||: Pause playing and recording. To resume, press ▶.
- REC PAUSE: Enter recording pause.
To start recording, press this button then ▶.

DVD player

You can always perform the following operation:

- STANDBY/ON \odot /I DVD: Turn on or off the DVD player.

After pressing DVD, you can perform the following operations on the DVD player:

- ▶: Start playing.
- ◀◀: Return to the beginning of the current (or previous) chapter.
- ▶▶: Skip to the beginning of the next chapter.
- : Stop playing.
- ||: Pause playing. To resume, press ▶.

After pressing DVD, these buttons can be used for the DVD menu operations.

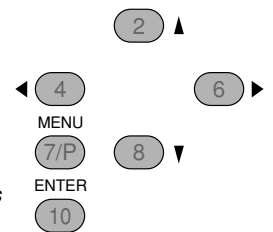

Note:

For detailed menu operations, refer to the instructions supplied with the discs or the DVD player.

TV

You can always perform the following operations:

- STANDBY/ON \odot /I TV: Turn on or off the TV.
- TV CH +/-: Change the channels.
- TV VOLUME +/-: Adjust the volume.
- TV/VIDEO: Set the input mode (either TV or VIDEO).

After pressing TV SOUND, you can perform the following operations on the TV:

- 1 – 9, 0, 100+ (+10): Select the channels.
- RETURN (10): Alternate between the previously selected channel and the current channel.

Troubleshooting

Use this chart to help you solve daily operational problems. If there is any problem you cannot solve, contact your JVC's service center.

PROBLEM	POSSIBLE CAUSE	SOLUTION
The display does not light up.	The power cord is not plugged in.	Plug the power cord into an AC outlet.
No sound from speakers.	Speaker signal cables are not connected.	Check speaker wiring and reconnect if necessary. (See page 5.)
	The SPEAKERS ON/OFF button is not set correctly.	Press SPEAKERS ON/OFF so that the sounds come out of the speakers. (See page 11.)
	An incorrect source is selected.	Select the correct source.
	Muting is activated.	Press MUTING to cancel the mute. (See page 13.)
	An incorrect input mode (analog or digital) is selected.	Select the correct input mode (analog or digital). (See pages 11 and 12.)
"NO SUBWOOFER" appears on the display.	The SUBWOOFER OUT ON/OFF button is pressed while "SUBWOOFER" is set to "SUBWOOFER NO."	If subwoofer is connected, set "SUBWOOFER YES" so that the SUBWOOFER OUT ON/OFF button works.
Continuous hiss or buzzing during FM reception.	Incoming signal is too weak.	Connect an outdoor FM antenna or contact your dealer. (See page 4.)
	The station is too far away.	Select a new station.
Noise is heard during FM/AM (MW) reception.	An incorrect antenna is used.	Check with your dealer to be sure you have the correct antenna.
	Antennas are not connected properly.	Check connections. (See pages 4 and 5.)
	Ignition noise from automobiles.	Move the antenna farther from automobile traffic.
"OVERLOAD" starts flashing on the display.	Speakers are overloaded because of high volume.	<ol style="list-style-type: none"> 1. Press STANDBY/ON \odot/I on the front panel to turn off the receiver. 2. Stop the playback source. 3. Turn on the receiver again, and adjust the volume.
	Speakers are overloaded because of short circuit of speaker terminals.	Press STANDBY/ON \odot /I on the front panel to turn off the receiver, then check the speaker wiring. If "OVERLOAD" does not disappear, unplug the AC power cord, then plug it back again. If speaker wiring is not short-circuited, contact your dealer.
"DSP NG" appears on the display.	The built-in microcomputer is not functioning correctly.	Press STANDBY/ON \odot /I on the front panel to turn off the receiver. After unplugging the AC power cord, contact your dealer.
The STANDBY lamp lights up after turning on the power, and soon the receiver turns off again (into standby mode).	The receiver is overloaded because of a high voltage.	Press STANDBY/ON \odot /I on the front panel to turn off the receiver. After unplugging the AC power cord, contact your dealer.
Remote control does not work.	There is an obstruction between the remote sensor on the receiver and the remote control.	Remove the obstruction.
	Batteries are weak.	Replace batteries. (See page 4.)
Remote control does not work as you intend.	An incorrect remote control operation mode is selected.	Select the correct remote control operation mode. (See pages 31 and 32.)

Specifications

Amplifier

Output Power

At Stereo operation

Front channels: 100 W per channel, min. RMS, driven into 8 Ω , at 1 kHz with no more than 0.8% total harmonic distortion (IEC268-3/DIN).

At Surround operation

Front channels: 100 W per channel, min. RMS, driven into 8 Ω , at 1 kHz with no more than 0.8% total harmonic distortion.

Center channel: 100 W, min. RMS, driven into 8 Ω , at 1 kHz with no more than 0.8% total harmonic distortion.

Surround channels: 100 W per channel, min. RMS, driven into 8 Ω , at 1 kHz with no more than 0.8% total harmonic distortion.

Audio

Audio Input Sensitivity/Impedance (1 kHz)

CD, TAPE/CDR, VCR, TV SOUND, DVD: 220 mV/47 k Ω

Audio Input (DIGITAL IN)*

Coaxial DIGITAL 1 (DVD): 0.5 V(p-p)/75 Ω

Optical DIGITAL 2 (CD):
-21 dBm to -15 dBm (660 nm \pm 30 nm)

* Corresponding to Linear PCM, Dolby Digital, and DTS Digital Surround (with sampling frequency—32 kHz, 44.1 kHz, 48 kHz)

Recording Output Level

TAPE/CDR, VCR: 220 mV

Signal-to-Noise Ratio ('66 IHF/DIN)

CD, TAPE/CDR, VCR, TV SOUND, DVD: 87 dB/62 dB

Frequency Response (8 Ω)

CD, TAPE/CDR, VCR, TV SOUND, DVD:
20 Hz to 50 kHz (+1 dB, -3 dB)

Equalization (5 bands)

63 Hz, 250 Hz, 1 kHz, 4 kHz, 16 kHz: \pm 8 dB (in 2 dB steps)

Video

Video Input Sensitivity/Impedance

Composite video

DVD, VCR: 1 V(p-p)/75 Ω

Video Output Level

Composite video

VCR, MONITOR OUT: 1 V(p-p)/75 Ω

Synchronization:

Negative

Signal-to-Noise Ratio:

45 dB

FM tuner (IHF)

Tuning Range:

87.50 MHz to 108.00 MHz

Usable Sensitivity

Monaural:

17.0 dBf (1.9 μ V/75 Ω)

50 dB Quieting Sensitivity

Monaural:

21.3 dBf (3.2 μ V/75 Ω)

Stereo:

41.3 dBf (31.8 μ V/75 Ω)

Stereo Separation at OUT (REC):

35 dB at 1 kHz

AM (MW) tuner

Tuning Range:

522 kHz to 1 629 kHz

General

Power Requirements:

AC 230 V \sim , 50 Hz

Power Consumption:

210 W (at operation)
1.5 W (in standby mode)

Dimensions (W x H x D):

435 mm x 146.5 mm x 369.5 mm

Mass:

7.5 kg

Designs and specifications are subject to change without notice.

RX-5052S

AUDIO/VIDEO CONTROL RECEIVER

JVC



EN

© 2005 Victor Company of Japan, Limited

1204RYMMDWJEIN